



# OWNER'S MANUAL

**A MAJOR CAUSE OF FIRES IS FAILURE TO MAINTAIN REQUIRED CLEARANCES (AIR SPACES) TO COMBUSTIBLE MATERIALS. IT IS OF UTMOST IMPORTANCE THAT THIS PRODUCT BE INSTALLED ONLY IN ACCORDANCE WITH THESE INSTRUCTIONS.**

TFB01WLB  
TFB85WLB  
TFB01WLB-A/E/G/H/L  
TFB85WLB-A/E/G/H/L

**SAVE THESE INSTRUCTIONS**

# IMPORTANT SAFETY

## READ ALL INSTRUCTIONS BEFORE INSTALLING AND USING THE APPLIANCE

Please read this entire manual before installation and use of this pellet-burning appliance. Failure to follow these instructions could result in property damage, bodily injury, or even death. Contact local building or fire officials about restrictions and installation inspection requirements in your area.

Cooking with a hardwood fire will bring years of enjoyment to you, your family, and those lucky friends you will be cooking for. Your new Traeger grill is specially designed to make cooking easier, while giving you optimal performance with the most savory-flavored food.

As with all grills and cooking appliances, any time you burn a material (whether it be wood, gas, or charcoal), organic gases are formed during the cooking process. One gas that can be particularly harmful in concentrated quantities is carbon monoxide. In an outdoor, open-air environment, carbon monoxide should naturally dissipate and not harm you.

**WARNING!** Follow these guidelines to prevent this colorless, odorless gas from poisoning you, your family, or others:

- Know the symptoms of carbon monoxide poisoning: headache, dizziness, weakness, nausea, vomiting, sleepiness, and confusion. Carbon monoxide reduces the blood's ability to carry oxygen. Low blood oxygen levels can result in loss of consciousness and death.
- See a doctor if you or others develop cold- or flu-like symptoms while cooking or in the vicinity of this appliance. Carbon monoxide poisoning, which can easily be mistaken for a cold or flu, is often detected too late.
- Alcohol consumption and drug use increase the effects of carbon monoxide poisoning.
- Carbon monoxide is especially toxic to mother and child during pregnancy, infants, the elderly, smokers, and people with blood or circulatory system problems, such as anemia or heart disease.
- Only use your Traeger outside on a noncombustible floor and away from combustible materials.
- Never use gasoline, gasoline-type lantern fuel, kerosene, charcoal lighter fluid, or flammable liquids to start or "freshen up" a fire in this appliance. Keep all such liquids well away from this appliance when in use.

**IMPORTANT: READ CAREFULLY AND RETAIN FOR FUTURE REFERENCE.**

If you are assembling this unit for someone else, provide this manual for the owner to read and save for future reference.

### DANGER!

For North American Consumers:

- Plug into an appropriate 3-prong outlet.
- An electrical supply with GFCI protection is required. To protect against shock hazard, locate a grounded 3-prong receptacle in reach of the 6' (1.8-m) power cord. When installing the receptacle, follow the National Electrical Code and local codes and ordinances.

For Consumers in the European Union:

- Plug into an appropriate earthed outlet.
- Do not remove earth prong or modify plug in any way. Do not use an adapter or extension cord.

### DANGER!

- Hazardous voltage is present, which can shock, burn, or cause death. Disconnect the power cord before servicing the grill unless otherwise noted in the Owner's Manual.
- If the supply cord is damaged, it must be replaced by the manufacturer, service agent or similarly qualified persons in order to avoid a hazard.
- Never use or store flammable liquids near the grill.
- Never use gasoline or lighter fluid to manually light your grill. Use ONLY alcohol gel for this procedure AND according to the instructions in the Owner's Manual.

**WARNING!**

Many parts of the grill will become very hot during operation. Care must be taken to avoid burns, both during operation and afterwards, while the grill is still hot.

- Never leave the grill unattended when young children are present.
- Never move the grill when it is operating.
- Let the grill cool thoroughly before moving or attempting to transport.

**WARNING!**

- When operating this grill, maintain a MINIMUM distance of 12 inches (30.5 cm) from the grill to combustibles.
- When operating this grill under overhead combustibles, a MINIMUM of 40 inches (1 m) is required.

**WARNING!**

- Assemble and operate this grill ONLY per the instructions in the Assembly Guide and the Owner's Manual.
- This grill is intended for OUTDOOR USE ONLY.
- Never use heating fuel pellets in the grill, due to potential hazardous contaminants and additives that may be present.
- For best results and flavor, use genuine Traeger Hardwood Pellets.

**CAUTION!**

- Always store wood pellets in a dry location, away from heat-producing appliances and other fuel containers.
- Keep the grill clean – See the cleaning instructions in this Owner's Manual.
- Do not use accessories not specified for use with this grill.

For Consumers in the European Union:

- This appliance is not intended for use by persons (including children) with reduced physical, sensory or mental capabilities, or lack of experience and knowledge, unless they have been given supervision or instruction concerning use of the appliance by a person responsible for their safety.
- Children should be supervised to ensure they do not play with the appliance.

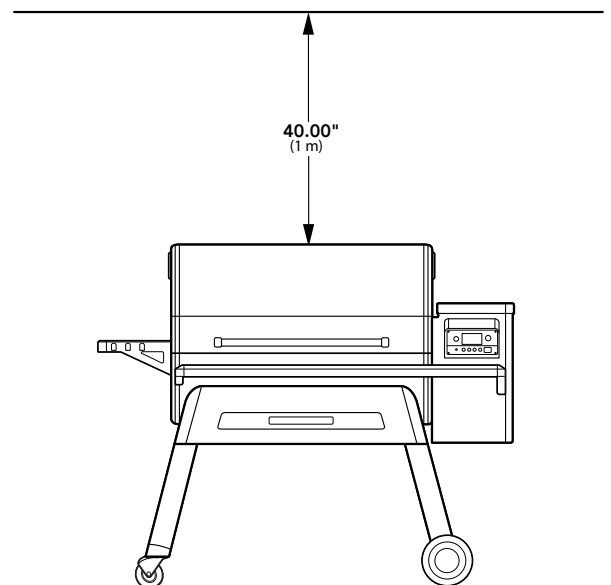
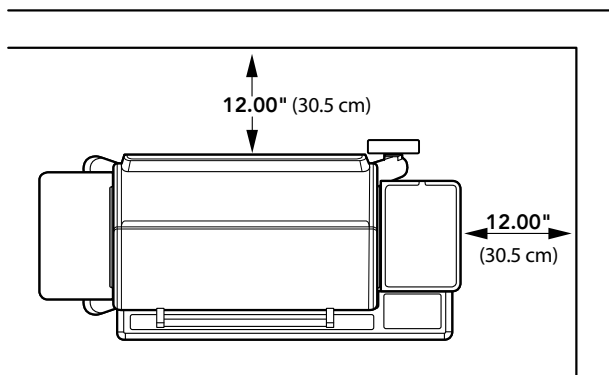

**SAVE THESE INSTRUCTIONS**





# WE'VE GOT YOU COVERED

[TraegerGrills.com/Shop](https://TraegerGrills.com/Shop)  
[TraegerGrills.com/Dealers](https://TraegerGrills.com/Dealers)

## RUBS



## PELLETS



## SAUCES





## TABLE OF CONTENTS

2	Important Safety
6	Adding Flavor to Your Fire
8	Getting to Know Your Grill
11	Priming the Grease Trap
12	Seasoning Your Grill
14	Using Your Grill
15	Choosing a Cook Method
21	Hopper Clean-Out
22	Timberline Features
24	Operating Tips
25	Maintaining Your Grill
27	Service and Warranty



**Register your grill  
online for a FREE  
Traeger ebook**

Go online at  
[traegergrills.com/register](http://traegergrills.com/register)



# ADDING FLAVOR TO YOUR FIRE

## PELLETS





























Creating 100% food-grade hardwood pellets comes naturally to Traeger®. Our four US mills process pure hardwood, blended for the perfect balance of smoke to heat and superior quality you can taste every time.

Crafting the highest-quality hardwood pellets on the market starts from the ground up. We built our plants in Oregon, Texas, and Georgia near the hardwood source, and we dedicate our manufacturing to food-grade pellets only, maintaining the purity of our machinery.

Traeger pellets contain two natural ingredients: our signature blend of hardwoods and a simple soybean oil. When manufacturing the premium hardwood pellets that elevate your meal to the next level, less is always more. No additives, no fillers, no binding agents — just simply natural flavor.

### HARDWOOD PELLET GUIDE

GOOD FOR ANYTHING. GREAT FOR:

ALDER	     
APPLE	   
CHERRY	   
HICKORY	   
MAPLE	   
MESQUITE	  
OAK	  
PECAN	    

## SPECIALTY SIZES

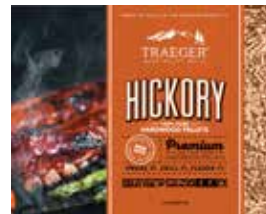

### **HICKORY** 10-lb. (4.5-kg) box **PEL104**

Our most popular pellet flavor now comes in an easy-to-transport 10-lb. box.



### **BIG GAME BLEND** 33-lb. (15-kg) bag **PEL320**

Traeger and Realtree have teamed up to bring you an exclusive blend of hickory and red and white oak, with woody rosemary undertones. This flavor is big enough for big game.

## 20-LB (9-KG) BAGS



**ALDER**  
20-lb. (9-kg) bag  
PEL307

Versatile because of its mild flavor and aroma, alder gives off ample smoke without overwhelming even the most delicate flavors.



**MAPLE**  
20-lb. (9-kg) bag  
PEL308

Mild, with a hint of sweetness, maple pellets are great for pork and especially veggies.



**APPLE**  
20-lb. (9-kg) bag  
PEL318

Most often used with poultry and pork, apple pellets offer a lightly sweet smoke that helps enhance mild-flavored meats.



**MESQUITE**  
20-lb. (9-kg) bag  
PEL305

A favorite of Texas BBQ, mesquite pellets infuse your meat with a robust smoke flavor.



**CHERRY**  
20-lb. (9-kg) bag  
PEL309

A very flavorful pellet, cherry wood lends itself to applications where you want to add a hearty smoke flavor.



**OAK**  
20-lb. (9-kg) bag  
PEL310

Stronger than cherry or apple and lighter than hickory, oak is great to use with fish and beef.



**HICKORY**  
20-lb. (9-kg) bag  
PEL319

The most widely used pellets in barbecue, hickory pellets release a rich flavor that complements most meats.



**PECAN**  
20-lb. (9-kg) bag  
PEL314

Deliciously nutty and even a little spicy, pecan pellets are great with veggies, beef, pork, poultry, or even baked goods.

# GETTING TO KNOW YOUR GRILL

Refer to the Assembly Guide to assemble and install your Traeger Timberline Grill.

## GRILL PARTS AND FEATURES\*

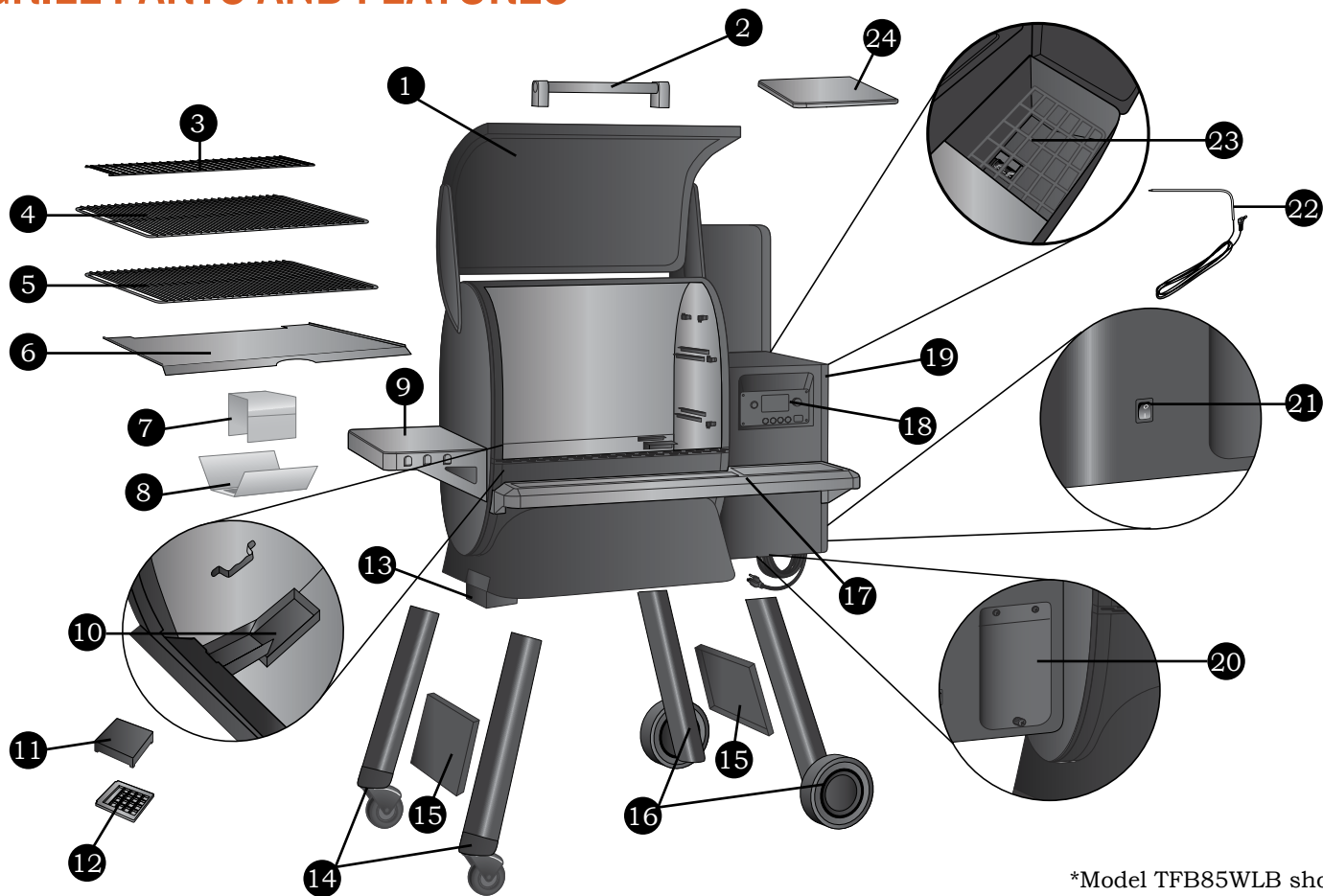

\*Model TFB85WLB shown

Part	Description	Part	Description
1	Grill Door	13	Grease Pan
2	Door Handle	14	Locking-Caster Legs
3	Top Grill Grate	15	Leg Braces
4	Middle Grill Grate	16	All-Terrain Wheel Legs
5	Bottom Grill Grate	17	Front Shelf
6	Grease Drip Tray	18	WiFIRE® Controller
7	Upper Heat Shield	19	Pellet Hopper
8	Lower Heat Shield	20	Hopper Clean-Out Door (back of grill)
9	Side Shelf	21	Main Power switch (back of grill)
10	Grease Trap Assembly (close-up)	22	Meat Probe
11	Black Cap for Grease Trap	23	Auger Assembly (close-up)
12	Grease Trap Screen	24	Cutting Board (placed atop hopper)



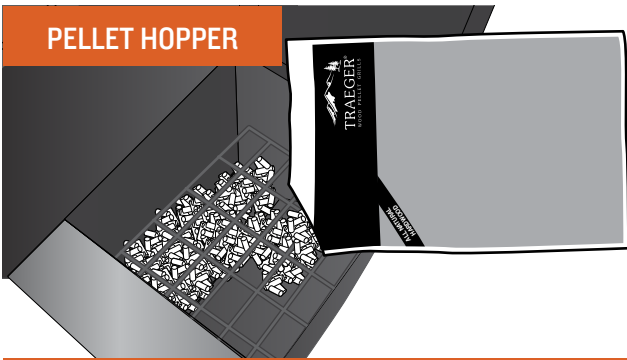

**PELLET HOPPER**

A 24-pound-capacity pellet hopper (10.8 kg) will keep you cooking for hours, getting you away from the grill and back to entertaining friends and family.

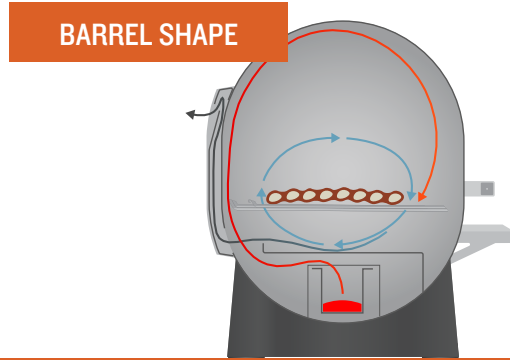

**BARREL SHAPE**

Traeger's signature barrel shape creates a vortex of convection. It circulates hot, smoky air around the cooking chamber, surrounding your food with 20,000-36,000\* BTUs of wood-fired heat for even cooking on all sides.

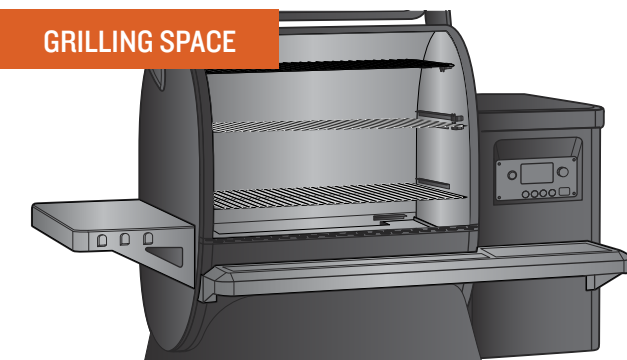

**GRILLING SPACE**

With 850-1300\* in.<sup>2</sup> (.55-.84 m<sup>2</sup>) of grilling space, your Traeger grill has the real estate for party-sized orders of T-bones or racks of ribs, with enough room left over to handle various side dishes, too.

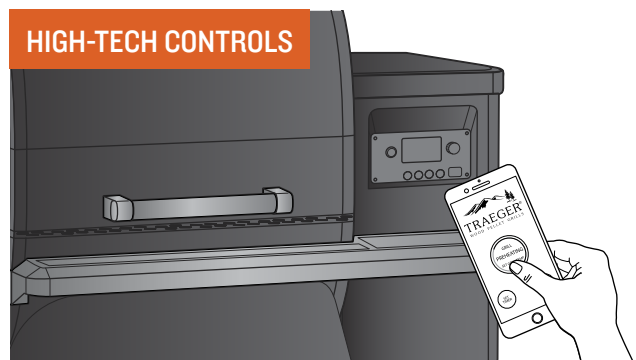

**HIGH-TECH CONTROLS**

With the Traeger Timberline Grill, multi-step cooking is as easy as pulling out your phone. The WiFIRE remote is programmed with custom cook cycles that can be cued up automatically with a recipe download from our Traeger App.



**VERSATILITY**

An adjustable three-tier stainless steel grate system offers options to load up all three grill grates for a true feast; remove the middle and top grates for taller food like Beer Can Chicken or a colossal turkey, or lower the bottom grate into a sear position for perfect grill marks.

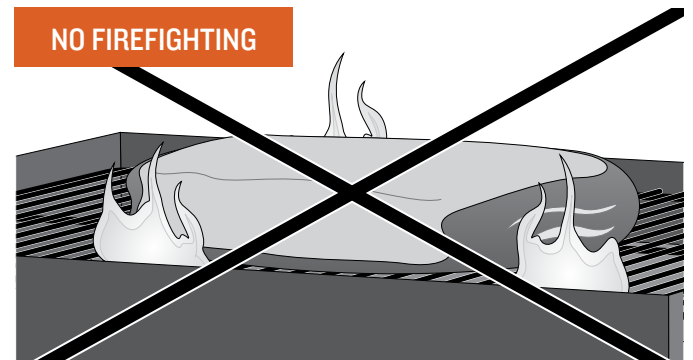

**NO FIREFIGHTING**

You don't have to worry about drippings flaring up and causing those nasty fireballs that destroy your meal, because Traeger Wood Fired Grills are designed to cook by using indirect heat. All drippings are safely channeled into an external grease pan for easy disposal.

\*Measurements vary according to model

# GETTING TO KNOW YOUR GRILL (cont.)

## YOUR WiFIRE® ELECTRONIC CONTROLLER

Your Traeger Timberline Grill is equipped with a state-of-the-art electronic controller that is Wi-Fi®-capable. Before you begin using the grill, it will be helpful to familiarize yourself with the different settings and button controls.

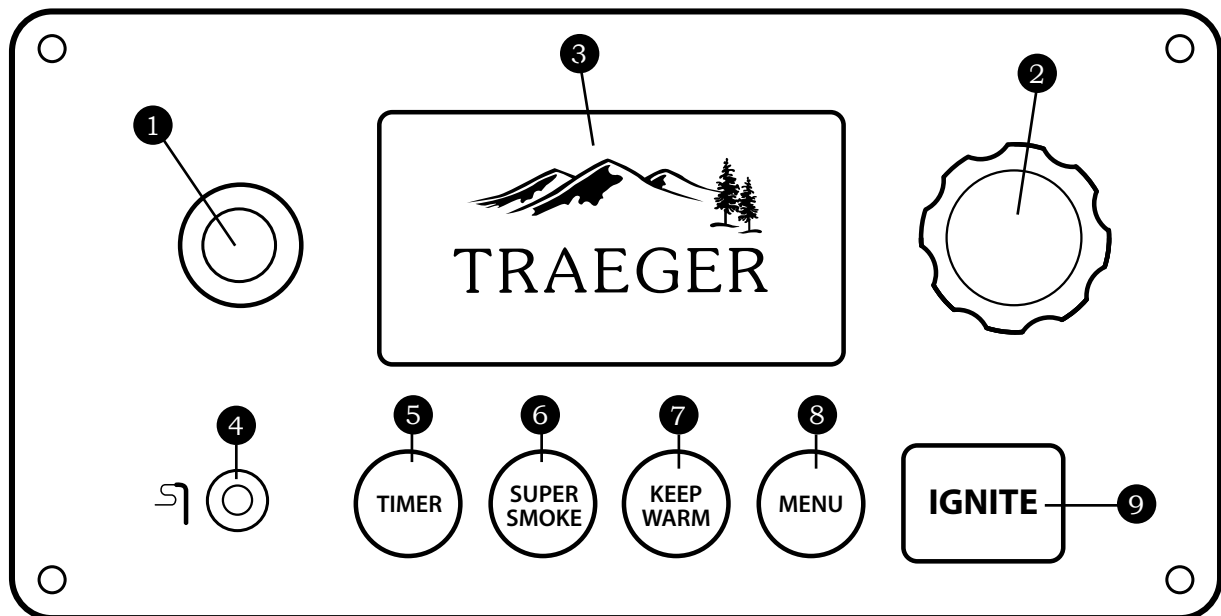

- 1 STANDBY BUTTON**  
Use this button to turn on the electronic controller once the Main Power switch has been turned ON.
- 2 SELECTION DIAL**  
Rotate dial to move up and down through the displayed menu. Press center of dial to make a selection.
- 3 STATUS DISPLAY**  
Shows current temperature, status of cook program, cook time remaining, etc.
- 4 MEAT PROBE**  
Plug the probe in where indicated for probe cooking.
- 5 TIMER**  
The timer is for your convenience only; it does not affect grill operation. For example, if you need to baste your meat in 15 minutes, set the timer for 15 minutes, and it will beep an alert when time's up.
- 6 SUPER SMOKE**  
Select SUPER SMOKE at any time during grilling when cook temperature is between 165° and 225°F (74°and107°C) to increase the amount of smoke released for additional smoky flavor.
- 7 KEEP WARM**  
This feature maintains the grill temperature at 165°F (74°C) to keep food warm without overcooking it.
- 8 MENU**  
From MENU, you can access the recipe library, set up the probe, sync your grill with your home's Internet as well as your mobile device, and change your grill's settings.
- 9 IGNITE**  
Press IGNITE to start the grill.

# PRIMING THE GREASE TRAP

Before you can get started smoking up some amazingly tasty food, you will need to prime the grease trap. The grease trap on your Traeger Timberline Grill acts as a barrier to redirect the cold smoke up towards the heat shield/chimney. In order for it to work correctly, follow these easy steps:

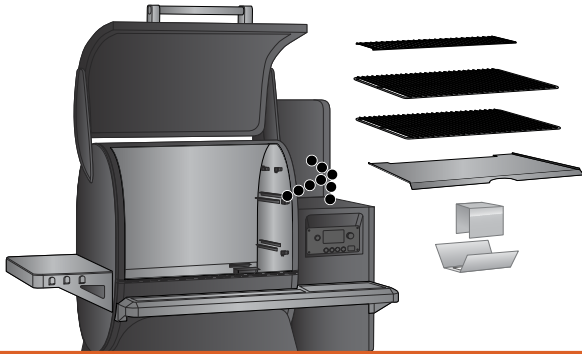

1

Remove all grill grates, grease drip tray, and heat shields.



2

Remove black cap from grease trap. Add about a cup of water (or flax seed oil, if desired) to the trap. Replace cap.

3

While the grill grates, grease drip tray, and heat shields are out of the grill, this is a good time to prime the auger. Go to "Seasoning Your Grill" and follow the easy steps there to get Traeger'ing.

**NOTE:** As you use your grill, the water in the grease trap will slowly be replaced by grease from the drip tray. If you see smoke coming out of the bottom of the grill, you will need to add more water to the trap to replace what's evaporated during the cooking process.



# SEASONING YOUR GRILL

## To be used on initial firing only.

Your Timberline Grill has a Prime Auger function to prepare your grill for use. You will be prompted to run this cycle on start-up.

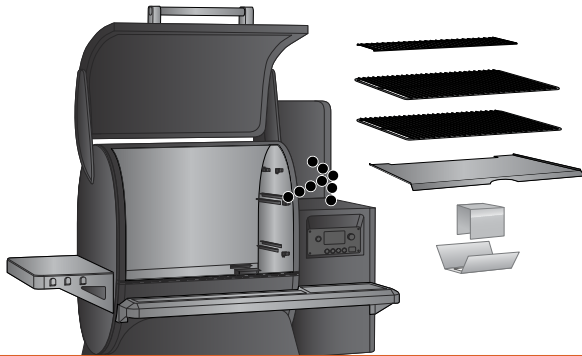

1

Remove grates, grease drip tray, and heat shields.

Plug appearance may vary by region.

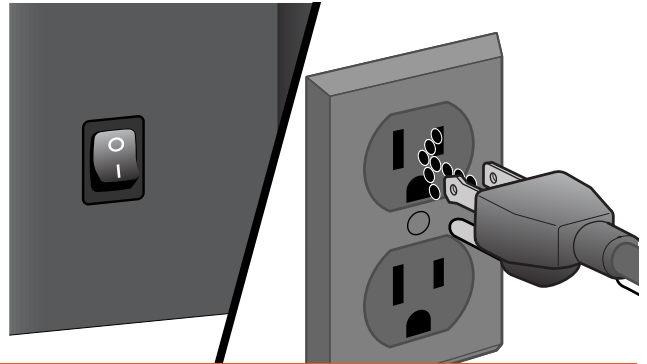

2

With the Main Power switch in the OFF (O) position, plug the power cord into an appropriate grounded/earthed electrical outlet.

**WARNING!** Use ONLY TRAEGER BRAND HARDWOOD PELLETS, which are specifically made to work in our grills. Never use heating fuel pellets in the grill.

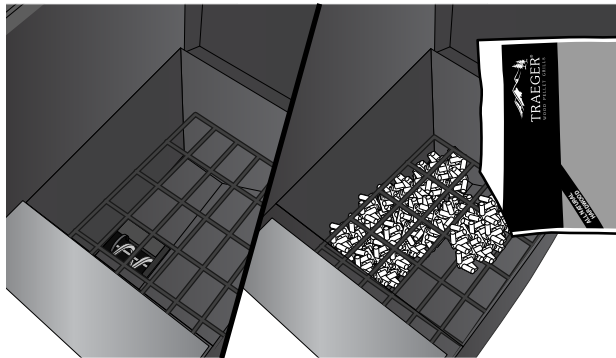

3

Make sure there are no foreign objects in the auger before adding pellets to the hopper.

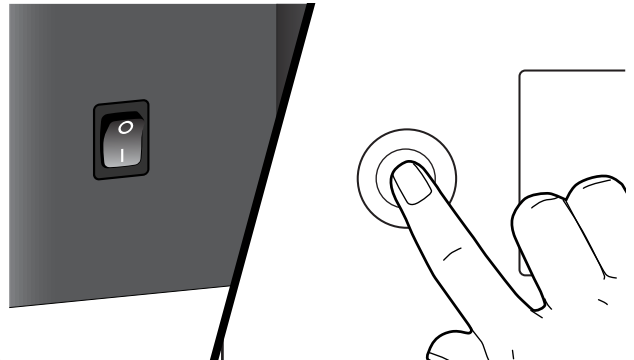

4

**Turn grill on:** Flip the Main Power switch on the back of the grill to ON (I), and then press the now-lit Standby button on the front control panel to activate the controller. After a few seconds, the home screen will display.

**NOTE:** The seasoning reminder will display the first few times you power up the grill. However, you only have to season your grill once.

**NOTE:** Whenever you're instructed to "select" a menu option, turn the Selection dial to the desired option and press the center of the dial to lock in your selection.

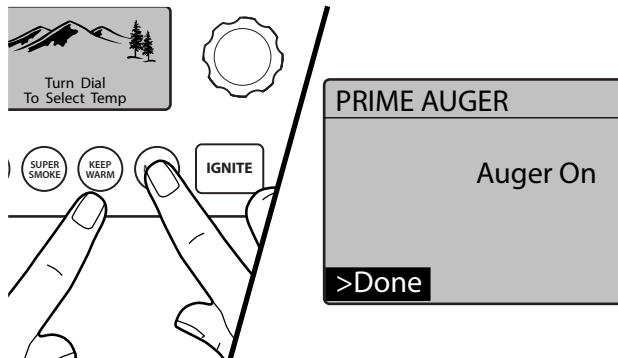
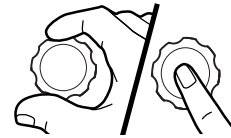

5

Press and hold the MENU button while you tap the KEEP WARM button. You will now be in the PRIME AUGER menu. Pellets from the hopper will begin to fall into the fire pot after they travel the length of the auger tube. This might take several minutes, depending on your grill model. Once pellets begin to fall into the firepot, select BACK to turn off the auger. You only need a few pellets in the firepot to season your grill.

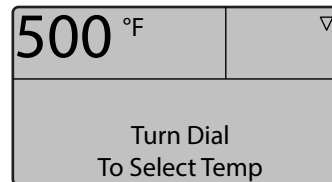

6

The home screen will display "Turn Dial To Select Temp." Turn the dial right until you reach 500°F (260°C). Press the dial center to select. Replace the heat shields, grease drip tray, and grill grates.

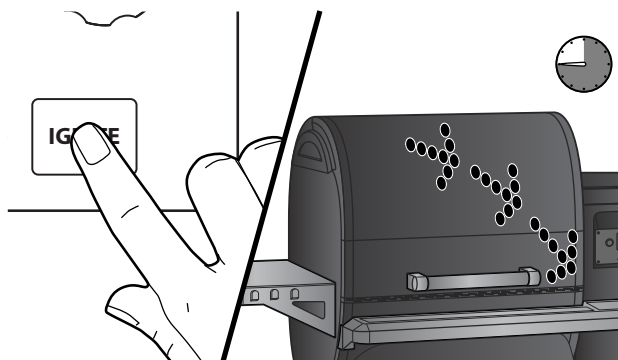

7

Press IGNITE. Your grill will immediately begin an automatic ignition and preheat cycle. Close grill door and allow grill to run for 45 minutes.

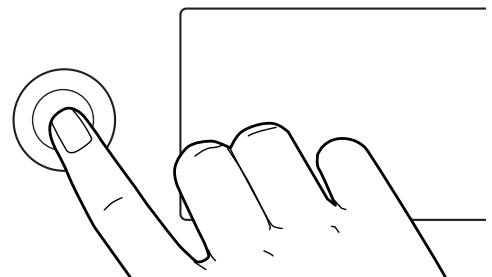

8

Turn off the grill by pressing and holding the Standby button for 3 seconds, initiating a 10-minute shut-down cycle. Your grill is now ready to use!

# USING YOUR GRILL

You will need to start with these two steps every time you use your grill.

**NOTE:** Whenever your grill is not in use, it should be disconnected from the electrical outlet; if left connected to the outlet, the Main Power switch should be flipped to OFF (O).

Plug appearance may vary by region.

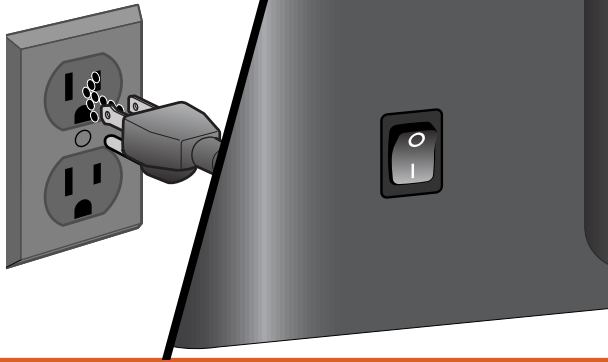

1

Plug power cord into an appropriate grounded/earthed electrical outlet and flip Main Power switch to ON (I).

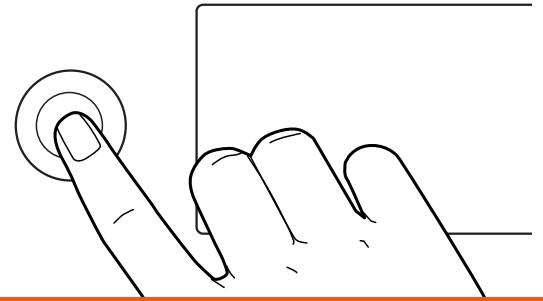

2

Push Standby button to wake the grill.

3

Once your grill is on and the home screen is displayed, choose one of these four options to cook your food: Cooking at a Single Temperature, Using a Preset Custom Cook Program, Creating a Custom Cook Program, or Cooking With the Probe. Each method is fully explained in the next section, "Choosing a Cook Method".

## NOTES:

- The Traeger App for your mobile device makes operating your electronic controller even easier. For more information on downloading the app and how to use it, refer to your Traeger App Quick Start Guide.
- Whatever cook method you choose, once you press IGNITE, your Timberline Grill will always begin with an ignition and preheat cycle and end with a 10-minute shut-down. When creating a Custom Cook program, those cycles will run automatically; you will not have to program them.
- We recommend you clean the grease drip tray frequently to reduce the possibility of a grease fire. Please see "Maintaining Your Grill" for more details.

## WARNING!

- When operating this grill, maintain a minimum clearance of 12 inches (30 cm) from grill to combustibles.
- Use ONLY TRAEGER BRAND HARDWOOD PELLETS, which are specifically made to work in our grills. Never use heating fuel pellets in the grill.



# CHOOSING A COOK METHOD

## COOKING AT A SINGLE TEMPERATURE

Use this method for simple recipes requiring a single cook cycle at a set temperature.

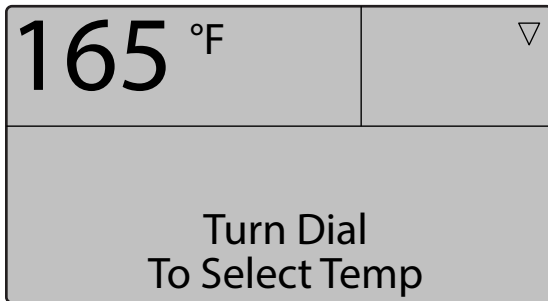

1

After pressing the Standby button, your grill's home screen defaults to the message "Turn Dial To Select Temp". Cooking temperature can be set directly from this screen.

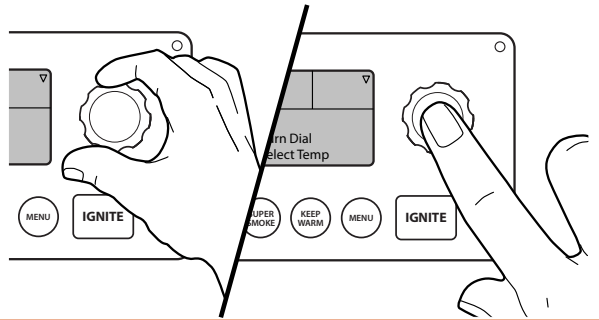

2

To select temperature, turn dial right or left; once desired temperature is displayed, press the center of the dial to select.

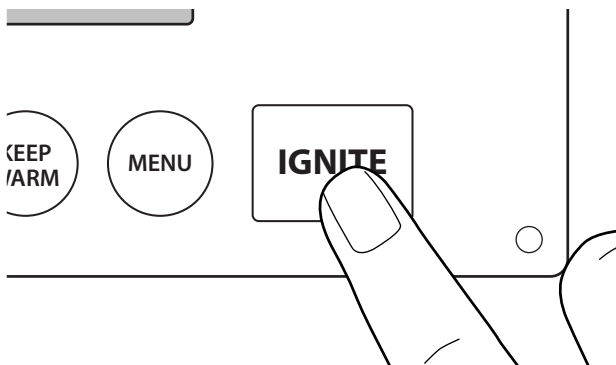

3

Press IGNITE. The automatic ignition and preheat cycle will begin.  
**NOTE:** Grill door should be closed once preheating begins.



4

Once preheating is complete, load food into the grill and close the grill door.

### NOTES:

- It is recommended, but not necessary, to wait until preheat cycle is complete before loading food into the grill.
- It is not necessary to keep grill door open at start-up; however, grill door should be closed once preheat cycle begins so that the grill can reach the desired set temperature.

# CHOOSING A COOK METHOD (cont.)

## USING A PRESET CUSTOM COOK PROGRAM

Your Timberline Grill comes with two of our favorite Custom Cook Programs already loaded: Beginner's Brisket and Chicken Challenge. Use your Traeger App to find hundreds of recipes and download them directly to your grill, once it's connected to the Internet.

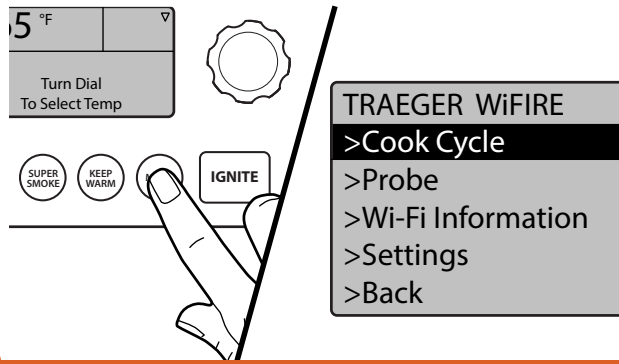

1

Once the home screen is displayed, press MENU. The full menu will now display several options. Select Cook Cycle.

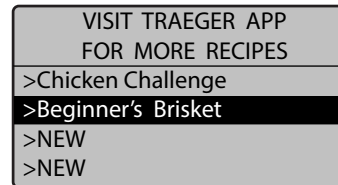

2

From the saved custom cook cycles displayed, choose the one you want using the Selection dial.

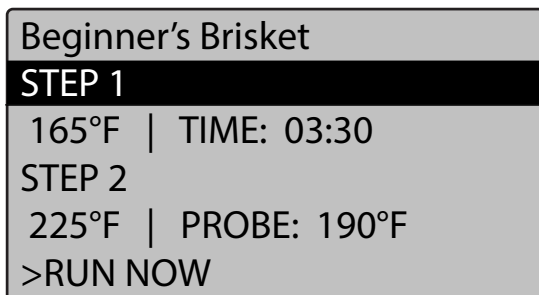

3

Once a custom cook cycle is selected, you will be able to see the included steps, or choose one of these options: RUN NOW, EDIT, DELETE, or BACK to return to the previous menu.

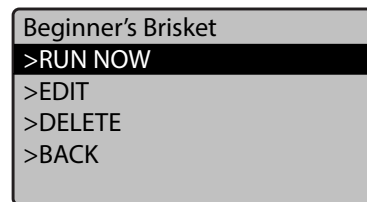

4

If you want to run the custom cook cycle exactly as-is, select RUN NOW. **NOTE:** To edit or add steps, follow the instructions in "Creating a Custom Cook Program".

**TIP:** If you're in the middle of programming a cook cycle and change your mind, just keep pressing MENU until you get back to the main menu, at which point you can start over.

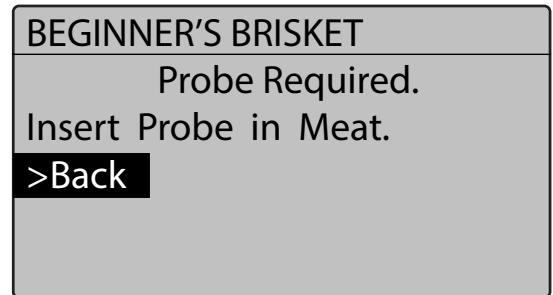
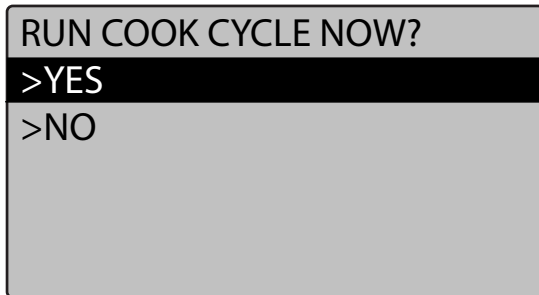

5

You will be asked to verify if you want to run the cook cycle now. Select YES.

6

If the probe is required, you'll be instructed to insert the probe into the meat. You'll hear a beep to acknowledge the probe once it is inserted into the control panel, and you'll again be asked if you want to run the cook cycle now. Select YES.

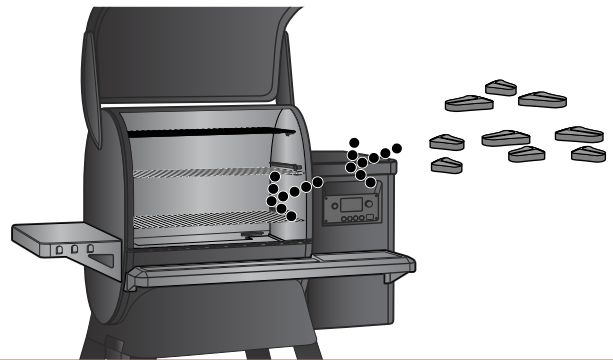
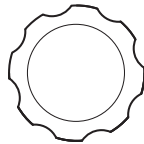
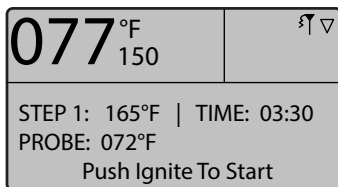

7

The display will now show the first step of your cook program. Press IGNITE to start.

8

The automatic ignition and preheat cycle will begin. Once preheating is complete, load food into the grill and close the grill door.

**NOTES:**

- If the probe is not plugged in properly, the grill will beep three times, loudly.
- It is recommended, but not necessary, to wait until preheat cycle is complete before loading food into the grill.
- It is not necessary to keep grill door open at start-up; however, grill door should be closed once preheat cycle begins so that the grill can reach the desired set temperature quickly.



# CHOOSING A COOK METHOD (cont.)

## CREATING A CUSTOM COOK PROGRAM

Use this method to create your own cook program, or to edit an existing program.

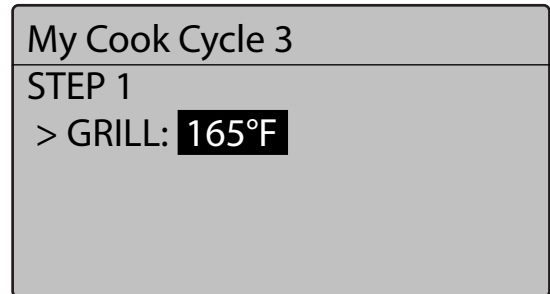
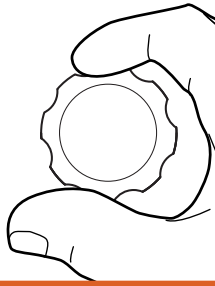
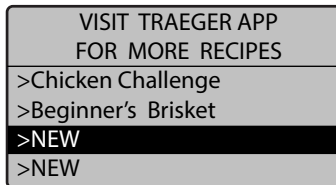

1

At the Cook Cycle menu, select NEW. The Steps menu will now display.

2

At Step 1, you will be prompted to choose a grill temperature (default temperature is 165°F [74°C]). Turn the Selection dial to the desired temperature and press to select.

**NOTE:** Custom Cook programs require a minimum of one step, with a maximum of four.

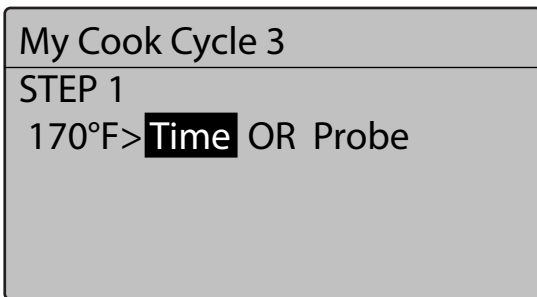

3

Once temperature is selected, you will have a choice of either Time (cook time) or Probe (internal temperature of meat).

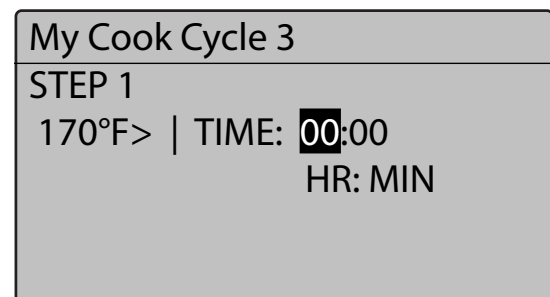

4

If your recipe calls for a specific number of hours at a set temperature, select TIME. Use the Selection dial to toggle between hours and minutes to set the time.

**REMINDER:** When using the Selection dial to choose options, remember to press in the center of the dial to lock in your choice and move to the next menu item.

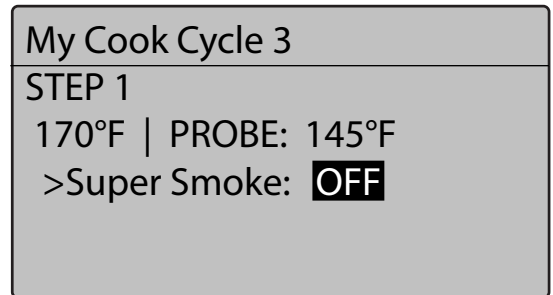
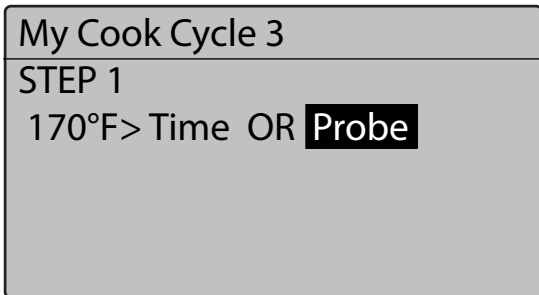

5

If your recipe calls for cooking your meat to a specific internal temperature, choose Probe. Use the Selection dial to select a goal temperature.

6

The option for adding Super Smoke to your step will display. To add Super Smoke, use the Selection dial to toggle from OFF (default) to ON. Otherwise, just press the dial center to accept the default setting. **NOTE:** Super Smoke can only be used when the grill temperature is between 165 and 225°F (74 and 107°C).

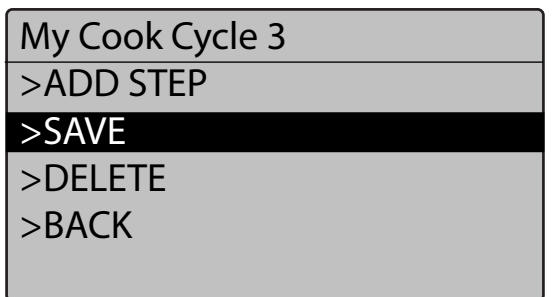
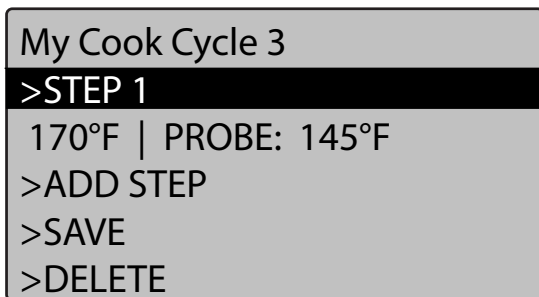

7

At this point you'll be returned to the Steps menu for your Custom Cook program. You can add another step, save the cook program as-is, delete the program, or return to the Cook Cycle menu (your step will be saved automatically).

8

Once all steps are added, select SAVE. You will be asked if you want to RUN COOK CYCLE NOW. If you select YES, you'll be taken back to the home screen and instructed to push IGNITE to start. If you select NO, you'll return to the Cook Cycle menu.

**NOTE:** There are four memory slots for recipes on your grill. If you have four recipes already saved and wish to create a new one, you will need to delete one of the current recipes to make room for the new one.

# CHOOSING A COOK METHOD (cont.)

## COOKING WITH A PROBE

Use this method when your recipe specifies an internal goal temperature for your food.

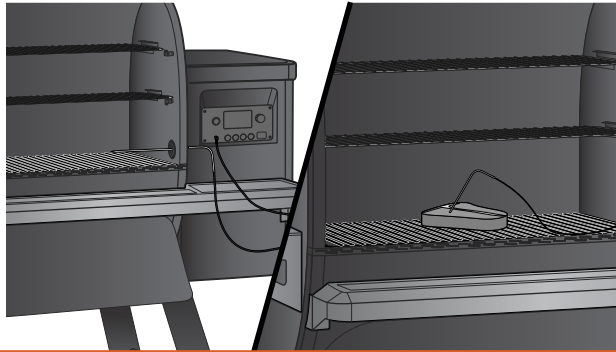

1

Turn grill on, and then load food into the grill. Thread probe through the grommet next to the control, and insert the probe tip into the meat. Make sure it's not in the fatty portion or touching bone, but is halfway into the thickest part of the meat.

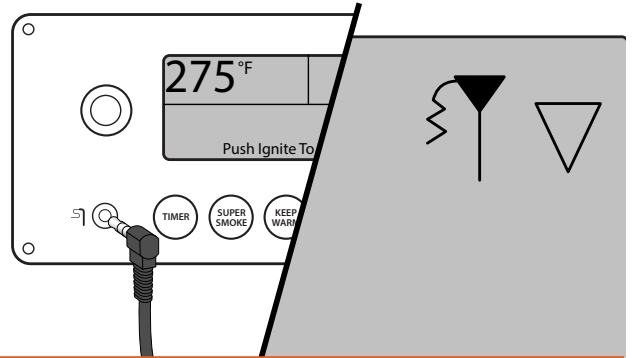

2

Select cooking temperature, then plug probe into probe receptacle on the controller. The grill will recognize the probe, and the probe icon will light in the upper-right corner of the screen.

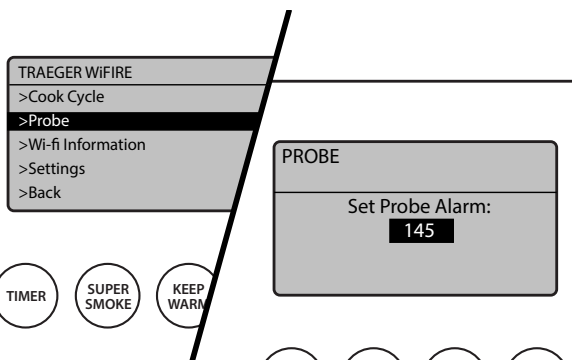

3

Press MENU, then select Probe. You will be prompted to set a probe alarm for the internal goal temperature. Select SET ALARM, and at the PROBE menu, use the selection dial to choose the desired goal temperature for your meat.

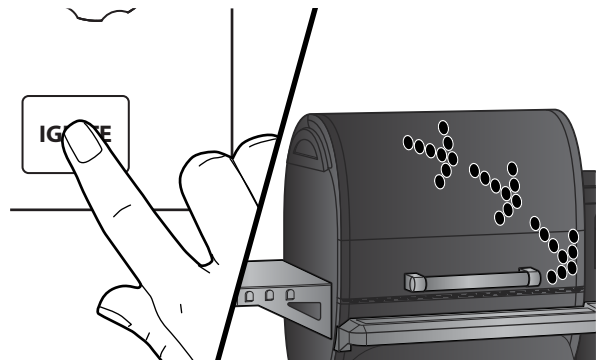

4

Once the probe alarm is selected, the home screen will display. Press IGNITE. The display will change to show the goal cook temperature, the goal probe temperature, and indicate status ("Igniting..."). Close the grill door. You will hear a notification beep when your meat reaches the desired temperature.

# HOPPER CLEAN-OUT

Your Traeger Timberline Grill has a hopper clean-out system that allows you to quickly change from one pellet flavor to another without making a mess.

Plug appearance may vary by region.

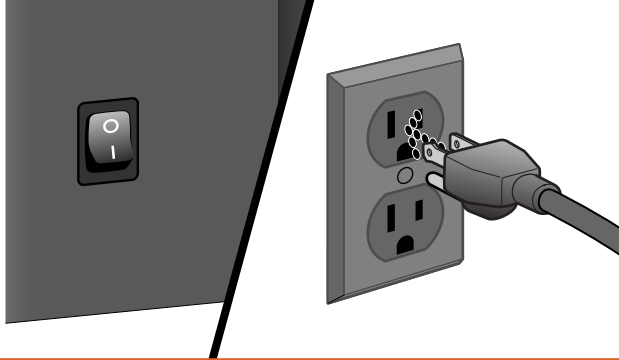

1

Turn the Main Power switch to OFF (O) and disconnect the power cord. If the grill is still hot, allow it to cool completely.

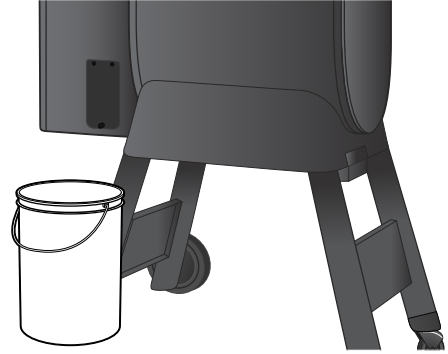

2

Place a container large enough to hold the discarded pellets under the pellet clean-out door.

**TIP:** A clean 5-gallon bucket works great!

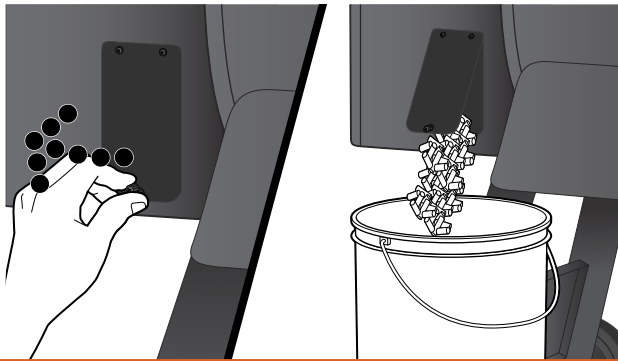

3

Unscrew the clean-out door fastener and open, allowing the pellets to empty into the container below it. You might need a spatula or spoon to push the remaining pellets out of the hopper.

**NOTE:** The pellets remaining in the auger do not need to be removed; they will burn through during your next warm-up cycle.



4

Once the hopper is empty, close the door, replace the fastener, and refill the hopper with a different flavor of Traeger Hardwood Pellets.

# TIMBERLINE FEATURES

## TRAEGER APP

Your Timberline Grill can be controlled remotely using the Traeger App. To use the Traeger App and connect your grill to your home's Wi-Fi, refer to the Traeger App Quick Start Guide found in your Manuals packet.

You will need a home Internet Wi-Fi connection to connect your Timberline Grill to the Internet. A smartphone or tablet running either iOS (8.2 and newer) or Android (4.4 and newer) is required. If you leave the range of your home Wi-Fi network with your device, a data plan is required.

The Traeger App is also an easy way to search, download, and cook new recipes on your Timberline Grill. You can also stock up on Traeger® Hardwood Pellets, or order grill accessories to optimize your grilling experience.

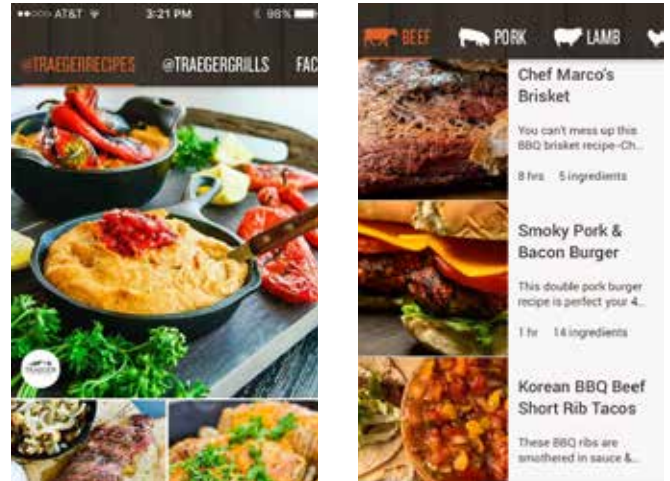

## TIMER

Your Timberline Grill comes equipped with a convenient timer. The Timer function does not impact grill operation; you can use it to notify you of other needed steps during cooking, like loading vegetables into the grill or basting your food.

### To set the Timer:

- Push and hold the TIMER button for 3 seconds.
- Rotate dial to select hours; press dial to select and move to minutes.
- Rotate dial to select minutes; press dial to select.

Once the dial is pressed after choosing minutes, the home screen will display; the timer is set.

### To cancel the Timer:

- Push and hold the TIMER button for 3 seconds
- You will see the options to EDIT, CANCEL, or go BACK to the menu.



## SUPER SMOKE OPTION

You can add more smoke flavor to your food by pressing SUPER SMOKE at any time during grilling. Press it again to cancel.

**NOTE:** Super Smoke can only be activated when grill temperature is between 165° and 225°F (74 and 107°C).

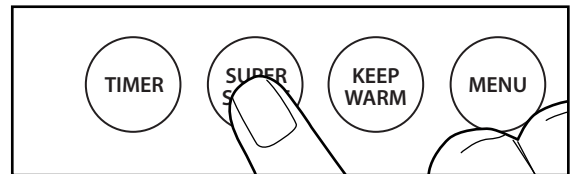

## KEEP WARM FUNCTION

Keep Warm can be used to pause the cook cycle at any time during grilling. Simply press KEEP WARM again to resume cooking. Keep Warm maintains the grill temperature at 165°F (74°C).

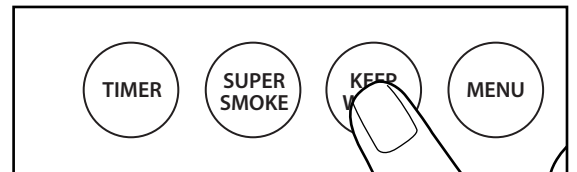



## VERSATILE LOWER GRATE

You can change the placement of the bottom grill grate for two different cooking options: Sear Position and Smoke Position.

In **Sear Position**, the grill grate should be placed at the lowest point in the grill body cavity, resting on the lowest back brackets and the lip at the front. This ensures that the radiant heat from the grease drip tray is maximized and your food has sear marks.

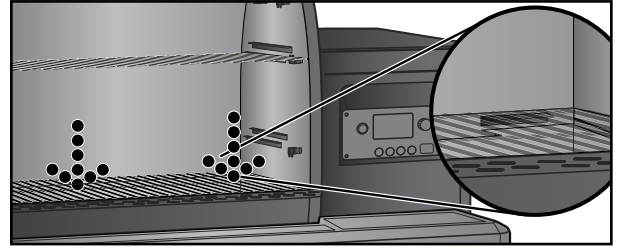

For **Smoke Position**, place the grill grate on the higher front brackets, sliding it into the channel at the back. This will allow the smoke to fully circulate for convection cooking.

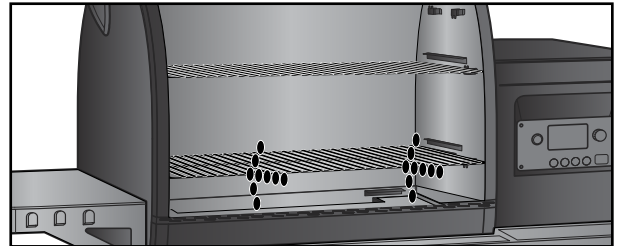

## RACK STOPS

Located at the front of the slider brackets for both the bottom and middle grates, rack stops provide additional stability when accessing food. Simply slide the grate out until the crossbar catches in the rack stop, and you'll be able to flip burgers or baste ribs easily without the rack tipping.

**NOTE:** Only move the bottom and middle grill grates; the top grill grate should remain in place since it does not slide.

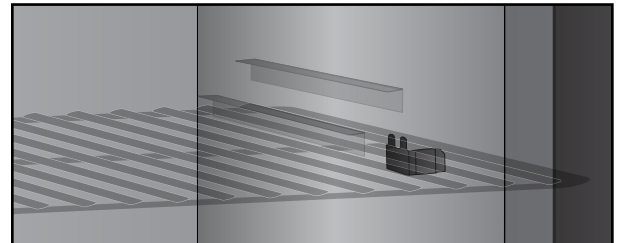

## CUTTING BOARD

For added convenience, your Timberline Grill includes a removable bamboo cutting board. Simply set the cutting board on top of the hopper and the magnetic base will hold it in place. For the proper maintenance and cleaning of your cutting board, see "Maintaining Your Grill" on page 25.

**IMPORTANT:** Do not leave the cutting board outside in the sun or exposed to high temperatures for long periods of time. High temperatures and sunlight may cause the board to warp.

**For consumers in North America:**

**IMPORTANT:** In accordance with guidelines from the American Heart Association, as with many products containing magnets, it is recommended that those with implantable pacemakers/defibrillators should use care with the cutting board and keep their device 12 inches (30 cm) away from the board.

**For consumers in the European Union:**

**IMPORTANT:** In accordance with guidelines from the medical device manufacturers, as with many products containing magnets, it is recommended that those with implantable pacemakers/defibrillators should use care with the cutting board and keep their device 30 cm away from the board.

## GRILL COVER

Protect your Timberline Grill with a premium custom cover, designed to withstand the elements. This durable grill cover is available for purchase at [traegergrills.com](http://traegergrills.com).

# OPERATING TIPS

1. You can change the temperature at any time during grilling to increase or decrease cooking temperature.

To change between Fahrenheit and Celsius:

- a. Press MENU.
- b. Select SETTINGS.
- c. Select TEMPERATURE UNITS.
- d. Choose either FAHRENHEIT (°F) or CELSIUS (°C).
- e. Select BACK.

You will now see temperatures displayed in the format you've chosen.

2. **WARNING!** Your Traeger Timberline Grill should never be moved while it is hot. If you are transporting your grill in a vehicle after cooking on it, make sure the fire is completely out and the grill is cold before placing it in any vehicle. Never put water into the firepot; it will jam the auger.
3. Your Traeger Timberline Grill is designed to operate with the door closed. Cooking with the door open greatly lengthens your cooking time.
4. **CAUTION!** Never add pellets by hand to a hot firepot. This is dangerous and you may be seriously burned. If you run out of pellets and lose your fire while cooking, let the grill cool completely and start again with the "HOPPER CLEAN-OUT" instructions on page 21.
5. **CAUTION!** Make sure the heat shield is properly seated on its locating brackets. If not seated properly, direct heat and flame could come up out of the firepot and cause a grease fire in the grill.

Always take into account the type of food you are cooking.

- Thin foods need high heat and shorter cook times, while thicker foods need low heat and longer cook times.
- Vegetables take longer to cook than meats at the same cooking temperatures.
- Always check that the internal temperature of the meat that you are cooking reaches safe temperatures to eat.
- The Keep Warm function is not designed to properly cook your food.

6. **WARNING!** If the fire in the firepot goes out while smoking and there are sufficient pellets still in the pellet hopper, it is important to follow these steps. Failure to do so may cause a hazardous "overfiring" of your grill due to an excess of unburned pellets in the firepot. **DANGER!** Turn the Main Power switch at the back of the grill to OFF (O) and disconnect the power cord. Allow the grill to cool thoroughly. Open the door and remove all food, grill grates, grease pan, grease drip tray, and heat shield.

**WARNING!** Remove all unburned pellets and ash from inside and around the firepot. (See instructions for proper handling and disposal of ash on page 26.)

Before replacing the heat shield, grease pan, grease drip tray, and the grill grates, plug the power cord into an appropriate grounded electrical outlet and turn the switch ON (I). Pellets should fall into the firepot and the hot rod should begin to heat (it will start to turn red). **CAUTION!** Do not touch the hot rod.

When flames start to come out of the firepot, turn the switch OFF (O). Let the grill cool down. Now you're ready to place the heat shields, grease drip tray, and grill grates back into the grill.

7. **CARBON MONOXIDE:**

**WARNING!** Follow these guidelines to prevent this colorless, odorless gas from poisoning you, your family, or others.

Know the symptoms of carbon monoxide poisoning: headaches, dizziness, weakness, nausea, vomiting, sleepiness, and confusion. Carbon monoxide reduces the blood's ability to carry oxygen. Low blood oxygen levels can result in loss of consciousness and death.

See a doctor if you or others develop cold- or flu-like symptoms while cooking or in the vicinity of this appliance. Carbon monoxide poisoning, which can easily be mistaken for a cold or flu, is often detected too late.

Alcohol consumption and drug use increase the effects of carbon monoxide poisoning.

Carbon monoxide is especially toxic to mother and child during pregnancy, infants, the elderly, smokers, and people with blood or circulatory system problems, such as anemia or heart disease.

## 8. GREASE MANAGEMENT:

**CAUTION!** Grease fires are caused by not properly maintaining the grill and failing to clean the Traeger Grease Management System (TGMS) on a consistent basis (see MAINTAINING YOUR GRILL). In the unlikely event of a grease fire while cooking, turn the switch OFF (O) and keep the door closed until the fire is completely out. Never keep the door open during a grease fire. If the fire does not go out, lightly sprinkle baking soda on the fire.

**CAUTION!** Be careful not to burn yourself. If this does not work, carefully remove the food from the grill and keep the door closed until the fire is completely out. Again, be careful not to burn yourself. When the grill is completely cool, remove all internal components. Clean any grease accumulation from the TGMS. Replace the grease drip tray and grill grates, restart the grill, and resume cooking.

# MAINTAINING YOUR GRILL

## 1. CREOSOTE AND GREASE FORMATION AND REMOVAL:

When wood pellets are burned slowly, they produce tar and other organic vapors that combine with expelled moisture to form creosote. The creosote vapors condense in the relatively cool flue exhaust of a slow-burning fire. As a result, creosote accumulates on the flue lining. When ignited, creosote makes an extremely hot fire. Airborne grease particles will travel through the cooking chamber, and some of this airborne grease will accumulate on the flue lining, similar to creosote, which could be contributory to a fire. Also, grease drippings from the food will fall onto the grease drip tray, and then into the Traeger Grease Management System (TGMS). The TGMS is composed of a (1) grease channel, (2) grease chute, (3) internal grease trap, and (4) grease pan with pan liner (see below).

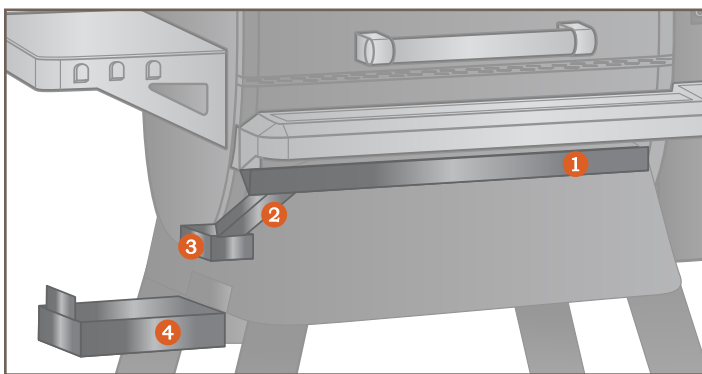

Grease drippings will flow from the grease drip tray to the grease channel, and then out of the grill through the grease chute, to be collected in the grease pan. Grease will accumulate in all of these locations.

The grease drip tray, the grease channel, and the grease chute should be inspected every eight times that you operate your grill for signs of grease buildup.

When creosote or grease has accumulated, it should be removed to reduce the risk of fire.

### Cleaning grease from your grill:

**DANGER!** Turn the Main Power switch OFF (O) and disconnect the power cord.

**CAUTION!** Accumulated grease is easier to clean off when the grill is still warm—not hot.

**Be careful not to burn yourself.**

Gloves are recommended.

Periodically clean the grease from the TGMS. If too much grease is allowed to build up in the grease channel or is allowed to plug the grease chute, a grease fire could result. We recommend cleaning these locations regularly.

Remove the grill grates and the grease drip tray. This will provide access to the grease channel and grease chute inside the grill. Scrape the grease accumulation from inside the grease channel and grease chute using a stiff, nonmetallic tool. Much of the loosened grease can be pushed down through the grease chute and will fall into the grease pan. Wipe up remaining grease residue with paper towels or disposable rags. Paper towels or disposable rags can also be used to wipe some of the grease off of the interior surfaces of the grill.

The grease pan comes with a preinstalled 5-pack of disposable aluminum liners. Replacement liner packs are available for purchase at [www.traegergrills.com](http://www.traegergrills.com). Empty the grease pan as needed; frequency depends on the amount of use.

# MAINTAINING YOUR GRILL (cont.)

## 2. CLEANING OUTSIDE SURFACES:

**DANGER!** Turn the Main Power switch OFF (O) and disconnect the power cord.

Use a disposable rag or cloth dampened with warm, soapy water to wipe the grease from the outside of the grill. DO NOT use oven cleaner, abrasive cleansers, or abrasive cleaning pads on the outside grill surfaces.

## 3. OUTSIDE STORAGE:

**CAUTION!** If the grill is stored outside during the rainy season, care should be taken to ensure that water does not get into the pellet hopper. Wood pellets expand greatly when wet and will jam your auger. Always cover your grill when not in use with the Traeger Grill Cover. This custom-fit cover can be purchased at [traegergrills.com](http://traegergrills.com).

## 4. CLEANING THE STAINLESS STEEL GRILL GRATES:

**CAUTION!** Cleaning the grill grates works best while they are still warm. **Be careful not to burn yourself.** We recommend keeping a long-handled cleaning brush near the grill. After removing your food, give the grill grate a quick brushing. It takes only a minute and it will be ready the next time you want to use the grill.

## 5. CLEANING THE ASH FROM INSIDE AND AROUND THE FIREPOT:

**WARNING!** Make sure that the grill is COLD before cleaning the ash.

**WARNING!** Disposal of ashes should be done only according to the following instructions.

Excess ash in the firepot may cause your fire to go out. The firepot should be inspected occasionally and cleaned to remove the ash buildup. Again, cleaning the ash from in and around the firepot should be done only when the grill is COLD.

Remove the grill grates, grease drip tray, and heat shield to provide access to the firepot and the interior of the grill. Much of the ash outside of the firepot can be removed from the grill with a small metal fireplace shovel or other similar tool.

**WARNING!** A vacuum cleaner is the best way to remove ashes from the firepot, but this must be done with extreme care to avoid the risk of fire. Again, cleaning the ash from the firepot should be done only when the grill is COLD.

A utility-type vacuum cleaner having a metal collection canister without a bag would be best for this task. However, almost any vacuum cleaner will work safely if this procedure is properly followed.

After ensuring that the ash in the firepot is COLD, vacuum the ash from the inside of the firepot.

- a. If your vacuum cleaner is a bagless model, empty any previously accumulated debris from the collection chamber. Then vacuum the ash from the inside of the firepot. Once the firepot is clean, empty the collection chamber into the metal container described below without delay. Make sure that there is no remaining ash residue left in the collection chamber.
- b. If your vacuum cleaner is a model that uses a disposable bag, install an unused bag in the machine. Then vacuum the ash from the inside of the firepot. Once the firepot is clean, remove the bag from the vacuum cleaner and place it in the metal container described below without delay.

## 6. DISPOSAL OF ASHES:

**WARNING!** Ashes should be placed in a metal container with a tight-fitting lid. The closed container of ashes should be placed on a noncombustible floor or on the ground, well away from all combustible materials, pending final disposal. When the ashes are disposed of by burial in soil or otherwise locally dispersed, they should be retained in the closed container until all cinders have cooled thoroughly.

## 7. CLEANING THE CUTTING BOARD:

Always thoroughly wash the cutting board after use.

**To wash:**

1. Hand wash only in warm, soapy water. DO NOT SOAK.
2. Rinse with clean water.
3. Air dry.

**IMPORTANT:** Soaking the wooden cutting board in water or washing it in the dishwasher can damage the board.

**NOTE:** Avoid overexposure to sunlight to prevent warping.

# SERVICE AND WARRANTY

**TRAEGER'S LEGENDARY CUSTOMER SERVICE** is the best out there. If you have any questions about your Traeger grill or need tips on cooking your first Thanksgiving turkey, our seasoned experts have your back. We're here for you 365 days a year including holidays, because we're cooks—not bankers.

For assistance with assembly or installation, parts, and customer service (English only, please), you can phone, e-mail, or write us at:

## TRAEGER'S CUSTOMER SERVICE

Phone: 1-844-9WiFIRE  
6:00 a.m. – 7:30 p.m. MT  
E-mail: [service@traegergrills.com](mailto:service@traegergrills.com)

## TRAEGER PELLET GRILLS LLC

1215 E. Wilmington Ave.  
Salt Lake City, UT 84106

## 3-YEAR WARRANTY (U.S.A. ONLY)

Traeger Pellet Grills LLC warrants this barbecue grill against defects in material and workmanship under normal use and maintenance for a period of three (3) years from the date of original purchase.

Traeger Pellet Grills LLC will provide a replacement part for any part found to be defective. Original part(s) approved for return by Traeger's Parts Department must be returned prepaid.

This warranty does not include labor charges connected with the determination or replacement of defective parts, or freight charges to ship these parts.

Traeger Pellet Grills LLC shall not be liable under this or any implied warranty for incidental or consequential damages. This warranty gives the retail customer specific legal rights and the customer may have other rights which vary from state to state.

This warranty shall be void if the unit is not assembled or operated in accordance with the operation instructions provided with this unit; the unit is resold or traded to another owner; components, accessories, or fuels not compatible with the unit have been used; the unit has been used in a commercial or food service application; or the user has abused or otherwise failed to maintain the unit.

To process a warranty claim, Traeger Pellet Grills LLC may require proof of your date of purchase. You should retain your sales slip or invoice along with this certificate with your valuable documents.







# LIVE FLAVOR FULL

**Traeger Pellet Grills LLC**  
**1215 E. Wilmington Ave**  
**Salt Lake City, UT 84106**

[traegergrills.com](http://traegergrills.com)