

Haier

User Manual Washing Machine

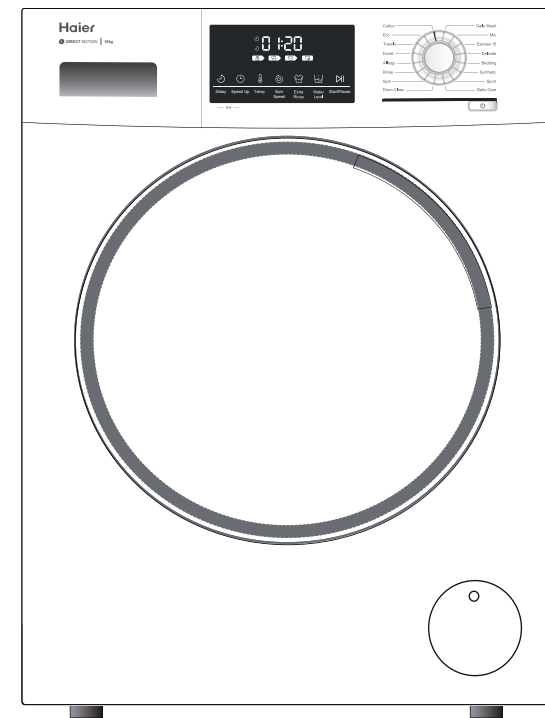

HWF10DW1

Thank you for purchasing a Haier product

Please read these instructions carefully before using this appliance. It contains important information which will help you get the best out of your appliance and ensure safe and proper installation, use, care and cleaning. Keep this manual in a convenient place so you can always refer to it for safe and proper use.

If you sell the appliance, give it away, or leave it behind when you move, make sure you also pass on this manual so that the new owner can become familiar with all features and safety warnings.

Legend



Yes



No



General information and tips



Warning! Important safety information!



Environmental information

Disposal

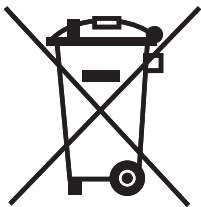

The presence of this symbol on the product, accessories or materials that goes with this information indicates that at the end of its useful life the product or its electronic accessories (e.g. cable, Aqua Stop hose) should not be disposed with other household waste. To prevent possible damage to the environment or human health from uncontrolled waste disposal, please separate these items from other types of waste and recycle them. This will promote the sustainable reuse of material resources. Household users should contact either the retailer where they purchased the product or relevant local authorities to find out how they can take this item for environmentally safe recycling and safety. Business users should contact their supplier and check the conditions of the purchase. This product and its electronic accessories should not be mixed with other commercial waste.

Safety.....	4-5
Installation.....	6-7
Product description.....	8
Control panel.....	9-11
Programmes.....	12
Consumption.....	13
Daily use.....	14-17
Care and cleaning.....	18-20
Troubleshooting.....	21-23
Technical data.....	24

This appliance is intended to be used in household and similar applications such as:

- ... staff kitchen areas in shops, offices and other working environments;
- ... farm houses;
- ... by clients in hotels, motels and other residential type environments;
- ... bed and breakfast type environments;
- ... areas for communal use in blocks of flats or in laundrettes;
- ... max. capacity 10 kg, water pressure 0.03-1MPa.

Before switching on the appliance for the first time...

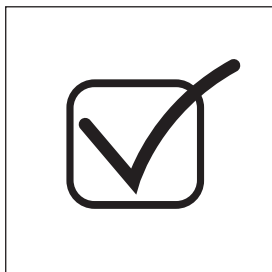

- ...make sure all transport bolts are removed.
- ...make sure the power cord is not caught under or in the appliance and there is no damage or risk for damaging.
- ...make sure the power circuit fuse is rated for 10A.
- ...use a separate earthed socket for the power supply.
- ...make sure the plug is always accessible.
- ...hold the plug and not the electric cable when unplugging the power supply.
- ...check that hose joints and connections are firm and by opening tap check for any water leaks.
- ...do not switch on the appliance until everything is properly installed!

Do not ...

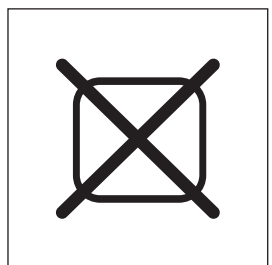

- ...allow children or infirm persons to play with the appliance or packing materials.
- ...install the appliance outdoors in a damp place, or in an area which may be prone to water leaks such as under or near a sink unit. In the event of a water leak cut power supply and allow the machine to dry naturally.
- ...expose machine to any frost, heat or direct sunlight.
- ...touch or use the appliance when barefoot or with wet or damp hands or feet.
- ...use flammable detergent or dry cleaning agent.
- ...use any flammable sprays in close vicinity to the appliance.
- ...remove or insert the plug in presence of flammable gas.
- ...place the appliance directly on a carpet, or close to a wall or furniture.

During daily use of the appliance...

The appliance is not to be used by persons (including children) with reduced physical, sensory or mental capabilities, or lack of experience and knowledge, unless they have been given supervision or instruction concerning use of the appliance by a person responsible for their safety.

Children should be supervised to ensure that they do not play with the appliance.

...supervise children.



Ensure that they don't play with the appliance and its packaging.

- ...ensure that appliance is not used by people with reduced physical, sensory or mental capabilities, or lack of experience and knowledge.
- ...pull up zips, fix loose threads and take care for small items to prevent laundry from being entangled. If necessary, use an appropriate bag or net.
- ...switch off at the wall socket after each wash programme to save electricity and for safety.
- ...keep the lower part of the porthole clean and open door and detergent drawer if appliance is not in use to prevent odours.
- ...a damaged power cord is only to be replaced by the manufacturer, service agent or other specifically qualified people.
- ...Use the hose-set supplied with the appliance. Old hose-sets should not be reused.

Do not ...

- ...connect water inlet valve to the hot water supply.
- ...touch the door during the washing process, as it may get hot.
- ...place heavy objects or sources of heat or damp on top of the appliance.
- ...hot wash from rubber or sponge-like materials.
- ...open detergent drawer during any wash cycle.
- ...force the door to open, it is fitted with a self-lock device and will open shortly after wash cycle end.
- ...open the door if the water level is visible over the porthole.
- ...cover or encase the appliance during operation or afterwards as it will restrict any moisture or dampness to evaporate.

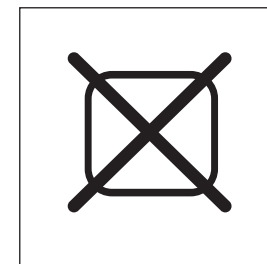
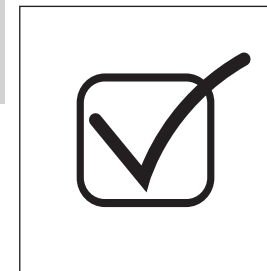

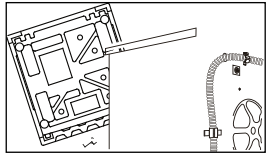

Preparation

Remove all packaging material including polystyrene base. While opening the package, water drops may be seen on plastic bag and porthole. This is normal as a result from water tests and quality control in the factory.

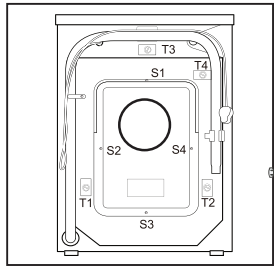

Note: Packaging disposal: 

Keep all packaging material out of children's reach and dispose them in an environmentally friendly manner.

Installing bottom plate

1. Lay the washing machine down to its side, window upwards, bottom side towards operator. Insert the bottom plate into the cabinet, then fixed with 2 screws to the cabinet on the window side.

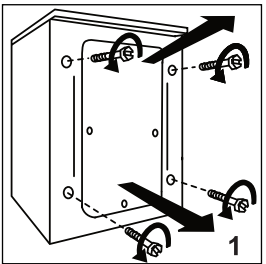

Removing the transportation bolts

The transportation bolts are designed for clamping antivibration components inside the appliance during transportation.

2. Remove all 4 bolts.

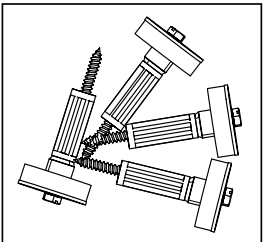

General information and tips:

Keep the transportation bolts in a safe place for later use. If the machine is to be moved to another location, replace transportation bolts contrariwise to prevent damage.

3. Fill the transportation bolt holes with blanking plugs.

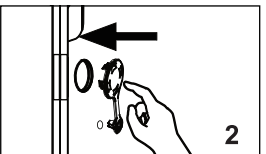

4. Adjust all feet to achieve a complete level position. This will minimize vibrations and noise during use. It will also reduce wear and tear. We recommend to use a spirit level for adjustment. Floor should be as stable and flat as possible.

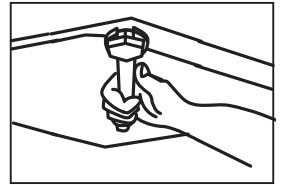

Inlet hose

1. Connect inlet hose to the machines water inlet valve.
2. Connect inlet hose to a water tap.
3. Tighten inlet hose connections and turn on water supply. Check for any water leaks. Stop all water leaks before continuing with installation.

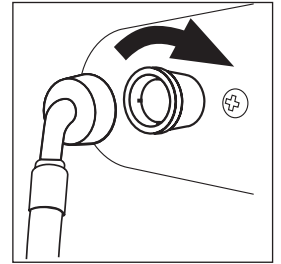

Warning! 

Appliance is only qualified for cold water supply!

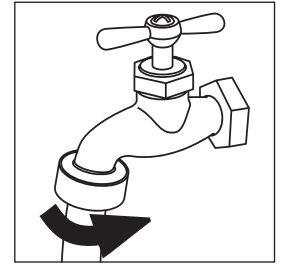

Drain hose

Drainage could be installed in different ways. Nevertheless, level of drain hose has to reach between 80-100 cm. If possible always keep drain hose fixed to the clip at the back of the appliance.

1. Drain hose to sink

Use the drain hose bracket to keep drain hose end retained and out of any water level. Fix the bracket securely to avoid dropping due to operational movements.

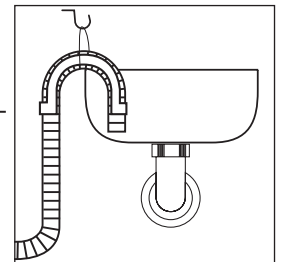

2. Drain hose to sink siphon

Connection has to be securely sealed and fixed to corresponding adapter above the siphoning part!

Warning! 

The drain hose should not be submerged in water and should be securely fixed and leak-free. If the drain hose is placed on the ground or if the pipe is at a height of less than 80 cm, the washing machine will continuously drain while being filled (self-siphoning).

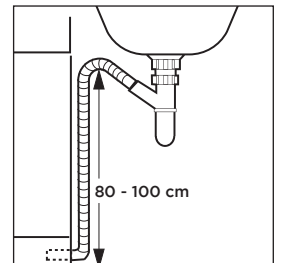

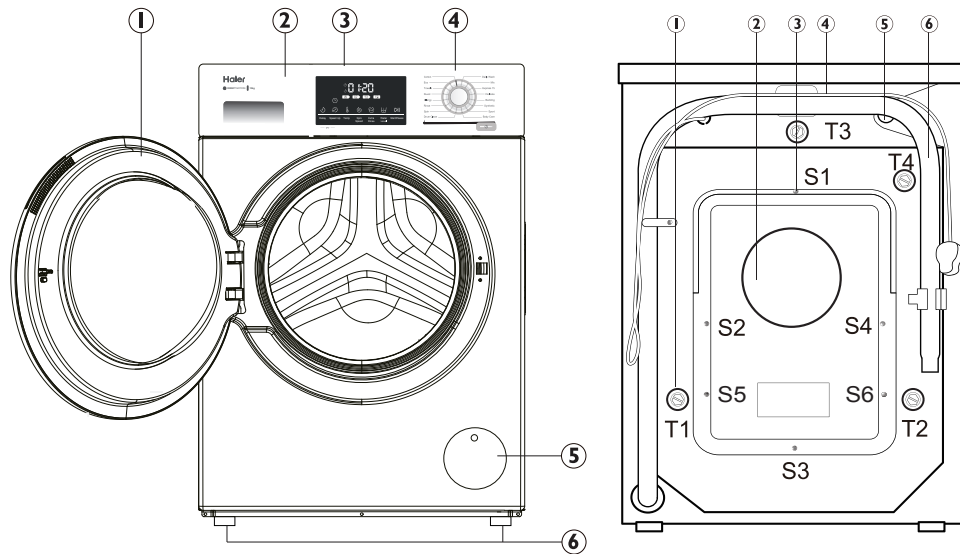

This drawing may be slightly different from the layout of the washing machine you have just purchased.

- | | |
|------------------------------|--------------------------------|
| 1. Door | 1 Transportation bolts (T1-T4) |
| 2. Detergent/Softener drawer | 2 Back cover |
| 3. Worktop | 3 Back cover screws(S1-S6) |
| 4. Control panel | 4 Power cord |
| 5. Pump filter cover | 5 Water inlet valve |
| 6. Adjustable feet | 6 Drain hose |

Accessories

Check the accessories and literature in accordance with this list.



Inlet hose assembly



5 blanking plugs



Drain hose bracket



Warranty-card



User manual

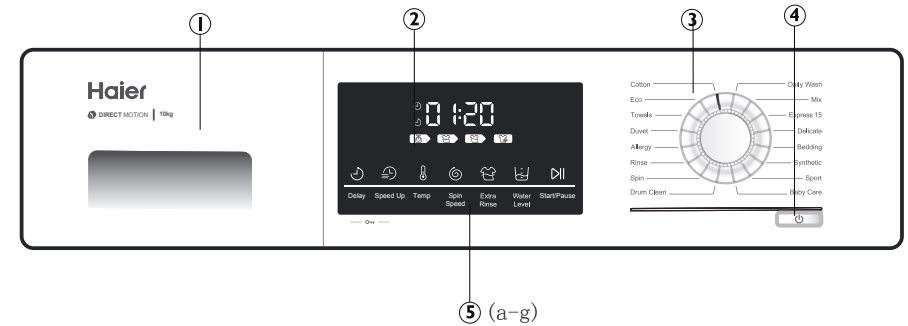

1. Detergent/Softener drawer
2. Display
3. programme selector
4. "On/Off" button
5. Function buttons (a-g)

- a. Delay
- b. Speed up
- c. Temperature
- d. Spin Speed
- e. Extra Rinse
- f. Water Level
- g. Start/Pause

Detergent drawer

Open the drawer and you will see two compartments
 Compartment 1: Detergent or Washing powder
 Compartment 2: Softener, Conditioning agent etc.

The recommendation on the type of detergents is dependant on the various washing temperatures. Please refer to the manual of detergent.

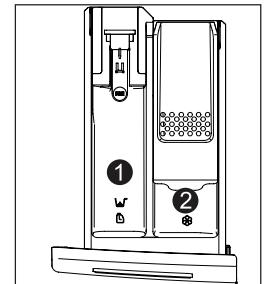

Display

If the appliance is on display will light up the actual status on six different sections (see next pages). During operation display will be deactivated after a while (Energy saving mode) until programme selector is turned at random.

Programme selector

By turning the dial one of 16 programmes can be selected, its default settings will be displayed.

"On/Off" button

Touch this button gently to switch on. The display will illuminate. Touch it again for about 2 seconds to switch off. If no panel element or programme is activated after a while, the machine will shut down automatically.

To get best results in each programme Haier has well defined specific default settings. If there is no special requirement default settings are recommended. According to these factory settings many programme parameters and additional functions could be individually changed.

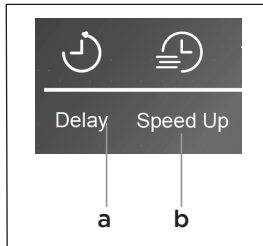

“Delay”-Start time delay (Button a)

Touch it to increase programme end time in increments of 30 minutes at most 24hr. Press the Start/Pause button once you are satisfied with the delayed end time. You will note the countdown of the delay time commence and subsequently the remaining programme cycle time will be displayed. The related symbol to the operation will display.

“Speed Up” (button b)

Touch it to reduce washing time.

General information and tips:

End time must always be longer than programme cycle time. Otherwise operation will start immediately, and the end time chosen will be never reached.

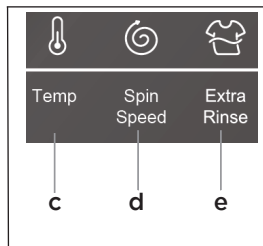

“Temp” (button c)

Touch it to change the washing temperature of the programme. If there is no value the water is not heated.

“Spin Speed” (button d)

Touch it to change or deselect the spin of the programme. If there is no value, the laundry will not spin.

“ Extra Rinse” (but ton e)

Touch it to rinse the laundry more intense with fresh water. This is recommended for people with sensitive skin. Zero to three additional rinse cycles are available.

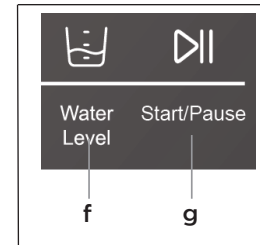

“Water Level” (button f)

Touch it to select a proper level of water. When selecting from L1 to L3, the water level increase gradually.

“Start/Pause ” (button g)

Touch it to start or interrupt the currently displayed programme.

“Child Lock” (button a+b)

The “Child Lock” function stops any further changes to the set program. To active, hold the “Delay” and “Speed Up” buttons at the same time for 3 seconds. Panel elements will be blocked after hearing an indicating voice. To deactivate the “Child Lock” hold the “Delay” and “Speed Up” buttons at the same time for 3 seconds.

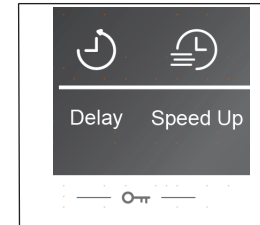

Display

The display shows following information:

1. Washing time
2. End time delay
3. Error codes and service information

Symbols of the display:



Programme table

- 1. Washing powder compartment
- 2. Detergent compartment
- 3. Softener compartment

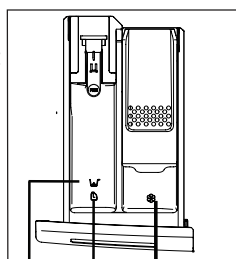

Programme	Temp.	Preset	1	2	3	Fibre Type	Preset
1. Cotton	0-90°C	30°C	<input checked="" type="checkbox"/>	<input checked="" type="checkbox"/>	<input type="checkbox"/>	Cotton/Synth.	1000 rpm
2. Eco	0-90°C	30°C	<input checked="" type="checkbox"/>	<input checked="" type="checkbox"/>	<input type="checkbox"/>	Cotton/Synth.	1000 rpm
3. Towels	0-90°C	60°C	<input checked="" type="checkbox"/>	<input checked="" type="checkbox"/>	<input type="checkbox"/>	Towels	1000 rpm
4. Duvet	0-40°C	40°C	<input checked="" type="checkbox"/>	<input checked="" type="checkbox"/>	<input type="checkbox"/>	Duvet	800 rpm
5. Allergy	0-90°C	60°C	<input checked="" type="checkbox"/>	<input checked="" type="checkbox"/>	<input type="checkbox"/>	Cotton/Synth.	1000 rpm
6. Rinse	---	---	<input checked="" type="checkbox"/>	<input checked="" type="checkbox"/>	<input type="checkbox"/>	---	1000 rpm
7. Spin	---	---	<input checked="" type="checkbox"/>	<input checked="" type="checkbox"/>	<input checked="" type="checkbox"/>	---	1000 rpm
8. Drum Clean	90°C	90°C	<input checked="" type="checkbox"/>	<input checked="" type="checkbox"/>	<input checked="" type="checkbox"/>	---	600 rpm
9. Daily Wash	0-60°C	30°C	<input checked="" type="checkbox"/>	<input checked="" type="checkbox"/>	<input type="checkbox"/>	Cotton farics	1000 rpm
10. Mix	0-60°C	30°C	<input checked="" type="checkbox"/>	<input checked="" type="checkbox"/>	<input type="checkbox"/>	Cotton/Synth.	1000 rpm
11. Express 15	0-40°C	---	<input checked="" type="checkbox"/>	<input checked="" type="checkbox"/>	<input type="checkbox"/>	Cotton/Synth.	1000 rpm
12. Delicate	0-30°C	30°C	<input checked="" type="checkbox"/>	<input checked="" type="checkbox"/>	<input type="checkbox"/>	Cotton farics	600 rpm
13. Bedding	0-60°C	40°C	<input checked="" type="checkbox"/>	<input checked="" type="checkbox"/>	<input type="checkbox"/>	Bedding	1000 rpm
14. Synthetic	0-60°C	30°C	<input checked="" type="checkbox"/>	<input checked="" type="checkbox"/>	<input type="checkbox"/>	Chemical fibre fabrics	1000 rpm
15. Sport	0-40°C	30°C	<input checked="" type="checkbox"/>	<input checked="" type="checkbox"/>	<input type="checkbox"/>	Sports Wear	1000 rpm
16. Baby Care	0-90°C	40°C	<input checked="" type="checkbox"/>	<input checked="" type="checkbox"/>	<input type="checkbox"/>	Cotton/Synth.	1000 rpm

Yes Optional No

The indicated consumption values may differ in local conditions.

Programme	Max load kg	Rinse Times	Water L	Temp	Washing time h:min	Spin drying performance %
1. Cotton	10	2	L-1	30	Auto	<60
2. Eco	10	2	L-1	30	Auto	---
3. Towels	5	2	L-1	60	1:36	---
4. Duvet	3	2	L-1	40	1:07	---
5. Allergy	5	3	L-1	60	1:51	---
6. Rinse	5	2	L-1	---	0:26	---
7. Spin	10	0	---	---	0:07	---
8. Drum Clean	0	1	L-1	90	1:00	---
9. Daily Wash	3	2	L-1	30	0:56	---
10. Mix	10	2	L-1	30	Auto	---
11. Express 15	3	1	L-1	---	0:15	---
12. Delicate	3	2	L-1	30	0:56	---
13. Bedding	7	3	L-1	40	1:42	---
14. Synthetic	5	2	L-1	30	Auto	---
15. Sport	3	1	L-1	30	1:01	---
16. Baby Care	5	3	L-1	40	1:35	---

General information and tips:



Standard programme for the Energy and Water Labelling according to AS/NZS 2040.2

Eco, 40°C, 1400 rpm, others are default setting.

Eco, 40°C, 1400rpm is the program for a normally soiled cotton load.

This appliance is only for domestic use inside the house. If it is used for commercial, industrial or not intended purposes any Haier guarantee will not be valid anymore. Consider instructions on each garment label and wash only machine-washable laundry.

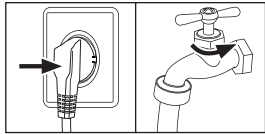

Power supply

Connect the washing machine to the power supply (220V to 240V/50Hz).

Water connection

Turn on the tap. The water must be clean and clear.

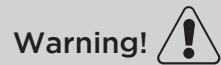

Warning! Before use, check for leakage in the joints between the tap and the inlet hose by turning on the tap.

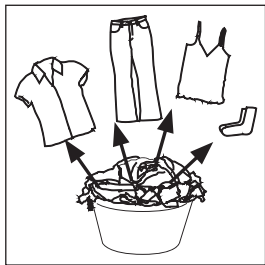

Preparing laundry

- Sort out clothes according to fabric (cotton, synthetics, wool or silk) and to how dirty they are. Pay attention to the care labelling of washing labels.
- Separate white clothes from coloured ones. Wash coloured textiles first by hand to check if they fade or run.
- Empty pockets (keys, coins, etc.) and remove harder decorative objects (e.g. brooches).
- Garments without hems, delicates and finely woven textile such as fine curtains are to be put into a wash bag (hand or dry cleaning would be better).
- Close zippers and hooks, make sure the buttons are sewn on tightly and place small items such as socks, belts, bras, etc. in a wash bag.
- Unfold large pieces of fabric such as bed sheets, bedspreads etc.
- Turn jeans and printed, decorated or color-intensive textiles inside out; If possible, wash them separately.

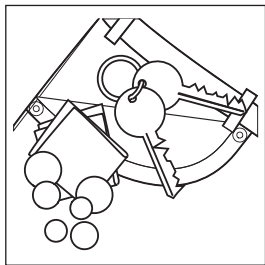

Warning! Non-textile, as well as small, loose or sharp-edged items may cause malfunctions and damage of clothes and appliance.

Loading the appliance

Open the door and put in the washing machine piece by piece. Close the door carefully.

Don't overload. Check if you can put a hand upright on top of load.

General information and tips:

After installation or long down time, run programme "Drum Clean" with no load and add detergent in washing agent compartment to remove possibly corruptive residues.

Selecting detergent

Washing efficiency and performance will vary depending on detergent quality. Use only machine wash approved detergent and if needed specific detergents, e.g. for synthetic and woolen fabric. Be mindful of always detergent manufacturer recommendations.

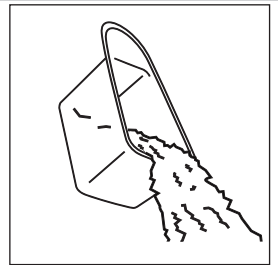

General information and tips:

Remove detergent residues before next wash cycle. Please follow given detergent dosage recommendation.

Adding detergent

Slide out the detergent drawer and put the required chemicals into corresponding compartments. Push back the drawer gently.

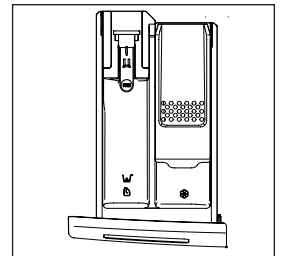

Select a programme

To get the best washing results, select the program that is most suitable to the laundry type loaded. Select program by turning the program selector dial.

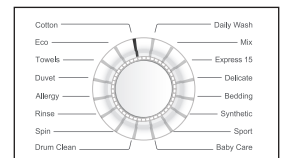

Add individual selections

Select required options and settings refer to “Control panel”.

Start wash programme

Touch “Start/Pause” button to start. Appliance operates according to selected settings. Changes are only possible by cancelling wash programme.



General information and tips:

1. For safety reasons the door is locked partially during the washing cycle. It is only possible to open the door at the end of the programme or after the programme was cancelled correctly (see description above).
2. In case of high water level, high water temperature and drum spinning it is impossible to open the door, Lock- is displayed.

Interrupt- cancel wash programme

To interrupt a running programme press gently “Start /Pause” button. Press it again to resume operation.

To cancel a running programme and all its individual settings activate “Start/Pause” and then hold “On/Off” for about 3 seconds.

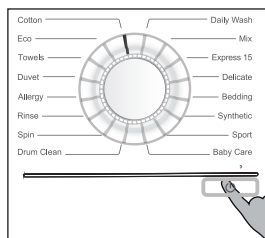

General information and tips:

Choose programme settings carefully referring to icons on each laundry label and “Care chart”. Removing laundry promptly at the end of cycle will minimise weinkling.





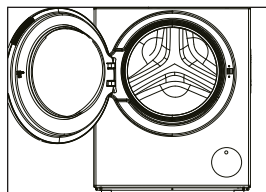





After washing

Turn off the water supply and unplug the power cord. Open the door to prevent formation of moisture and odours. Leave it open while not used.





Care chart





Washing Process

 Maximum washing temperature 90°C - normal process	 Maximum washing temperature 60°C - normal process	 Maximum washing temperature 60°C - mild process
 Maximum washing temperature 40°C - normal process	 Maximum washing temperature 40°C - mild process	 Maximum washing temperature 40°C - very mild process
 Maximum washing temperature 30°C - normal process	 Maximum washing temperature 30°C - mild process	 Maximum washing temperature 30°C - very mild process
 Wash by hand max. temp. 40° C	 Do not wash	





Bleaching Process

 Any bleaching agent allowed bleach allowed	 Only oxygen / non-chlorine	 Do not bleach
--	--	---





Tumble Drying Process

 Tumble drying possible normal temperature	 Tumble drying possible lower temperature	 Do not tumble dry
 Line drying	 Flat drying	

Ironing Process

 Iron at a maximum sole-plate temperature of 200°C	 Iron at a maximum sole-plate temperature of 150°C	 Iron at a maximum sole-plate temperature of 110°C without steam (steam ironing may cause irreversible damage)
 Do not iron		

Professional Textile Care Process

 Professional dry cleaning in tetrachloroethene	 Professional dry cleaning in hydrocarbons	 Do not dry clean
 Professional wet clean	 Do not professional wet clean	

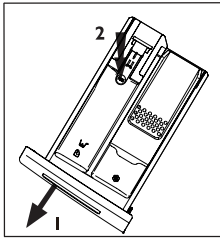

Cleaning the detergent drawer

Clean the drawer from detergent residues regularly. Pull out the drawer until it stops (1) and press the release button (2) to remove the drawer. Then flush the drawer with water until it is clean and insert the drawer back in the appliance.

Cleaning the machine

Unplug the machine during cleaning and maintenance. Use a soft cloth with soap liquid to clean the machine case and rubber components. Do not use organic chemicals or corrosive solvents.

Cleaning the drum

Remove accidentally washed metal parts, such as pins, coins, etc. from the drum because they cause rust stains and damage. Use a non-chloride cleaner for removing rust stains. Observe the warning hints of the cleaning agent manufacturer. Do not use any hard objects or steel wool for cleaning.

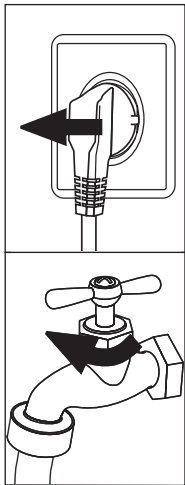

Cleaning the machine

If the appliance is left idle for a long period:

1. Pull out the power plug.
2. Turn off water supply.
3. Open the door to prevent formation of moisture and odours. Let door open while not used.
4. To prevent drying out, do not leave the dispenser lids open for a long period of time.
5. Empty, clean and dry the detergent drawer.

Before next usage check carefully power cord, water inlet and drain hose. Make sure everything is properly installed and no leakage.

Pump filter

Clean the filter once a month and check the pump filter immediately if the appliance:

- doesn't drain the water.
- doesn't spin.
- causes unusual noise while running.

Warning!



Scalding Risk! Water in the pump filter can be very hot! Before and action please ensure water has cooled down.

1. Turn off and unplug the machine.
2. Open service flap at the right corner of appliance front.
3. Provide a flat container to catch leach water. There could be big amounts!
4. Pull the drain hose out and hold its end above the container.
5. Take the sealing plug out of the drain hose.
6. After complete drainage close drain hose and push it back into the machine.
7. Unscrew and remove counter clockwise the pump.
8. Remove contaminants and dirt.
9. Clean pump filter carefully.
10. Refix it thoroughly.
11. Close service flap.

General information and tips:

Pump filter sealing has to be clean and unhurt. If the lid is not full tightened, water will escape. The filter must be in place, or it may lead to leakage.

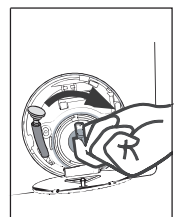
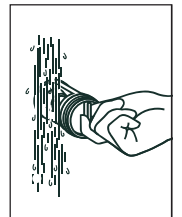
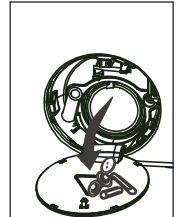
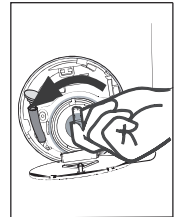
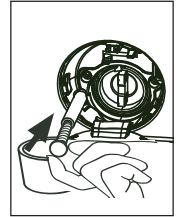
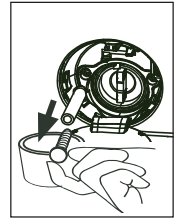

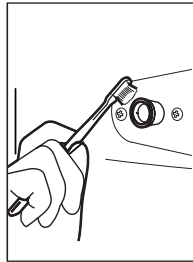
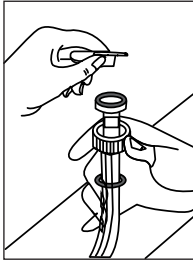

Water inlet valve and inlet valve filter

To prevent blockage of water supply by solid substance like lime clean regularly the inlet valve filter.

- Unplug the power cord and turn off the water supply.
- Unscrew the water inlet hose at the back of the appliance as well as on the tap.
- Remove the filters and flush them with water and a brush.
- Insert the filter and install the inlet hose.

Choose the best Detergent

	Universal	Colour	Delicate	Special	Softener
ECO	L/P	L/P	-	-	O
Synthetic	L/P	L/P	L	-	O
Cotton	L/P	L/P	-	-	O
Express 15	L	L	-	-	O
Delicate	-	-	L	-	O

	Detergent	Temperature range in °C
L	Liquid	cold - 60
P	Powder	40 - 90
o	Optional	---
-	No	---

If using liquid detergent, it is not recommended to activate the delayed start. Refer to the detergent manufacturers packaging for recommended dosage!

info: Modern washing detergents at low temperatures.

Display code

Code	Cause	Solution
Auto	Automatic load detection	Laundry weight detection in process. please wait until program cycle time is displayed.
1:25	Remaining wash cycle time.	
19:30	Remaining delay end time	Likely showing the delay end operation.
Lock	Door cannot be opened due to water level or hot water in the drum, or if the drum is still moving, wait for it to stop before attempting to open the door.	Wait for the program to end or cancel the program and select the Spin programme. In case there is still hot water in the drum, to avoid scalding, select the Rinse programme and leave it to wash for several minutes then select the Spin program. This should allow the drum to cool down.
End	End of cycle.	
FLr FLtr	Drainage error, water not emptied	Clean pump filter. Check drain hose for blockage, and ensure it is installed properly.
E2	Lock - error with door	Shut the door properly
E4	Water level not reached after 8 minutes.	Check if water supply and water pressure is normal. Drain hose is self-syphoning.
E8	Water protective level-error.	Auto release. Otherwise contact the after sales service.
F3	Temperature sensor-error.	Contact the after sales service.
F4	Heating error (Appears at the end of a cycle)	Contact the after sales service.
F7	Motor - error.	Contact the after sales service.
FA	Water level sensor error.	Contact the after sales service.
FCX (X=1,2,)	Electronic control - error.	Contact the after sales service.
Unb	Unbalanced load and not able to spin.	Check and balance the laundry load in the drum. Also reduce the load if too heavy. Restart with a spin program.

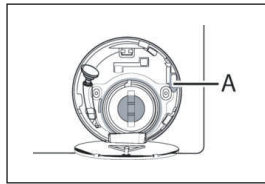

In case of power failure

The current programme and its setting will be saved. When power supply is restored, operation will be resumed.

If a power failure cuts an operating wash programme door opening is mechanically blocked. To get out any laundry water level should not be seen in the glassy porthole of the door. - Danger of burns! Water level has to be lowered as described in "Pump filter". Not till then pull level(A) beneath service flap until door as unlocked by a gentle click. Afterwards refix all parts.

Troubleshooting without display code

Problem	Cause	Solution
Washing machine fails to operate	<ol style="list-style-type: none"> 1. Power failure 2. Machine hasn't been switched on. 3. Door is not properly closed. 4. Programme is not yet started 	<ol style="list-style-type: none"> 1. Check power supply. 2. Switch the machine on. 3. Close the door properly. 4. Press "START/PAUSE" button.
Washing machine will not fill with water.	<ol style="list-style-type: none"> 1. No water 2. Inlet hose is kinked. 3. Inlet hose filter is blocked. 4. Water pressure is less than 0.03Mpa. 5. Door is not properly closed. 6. Water supply failure. 	<ol style="list-style-type: none"> 1. Check water tap. 2. Check inlet hose. 3. Unblock inlet hose filter. 4. Check water pressure. 5. Close the door properly. 6. Ensure the water supply.
Machine is draining while being filled.	<ol style="list-style-type: none"> 1. Height of drain hose is below 80cm. 2. Drain hose end could reach into water. 	<ol style="list-style-type: none"> 1. Make sure that drain hose is properly installed. 2. Make sure the drain hose is not in water.
Drainage failure.	<ol style="list-style-type: none"> 1. Drain hose is blocked. 2. Pump filter is blocked. 3. Drain hose end is higher than 100cm above floor level. 	<ol style="list-style-type: none"> 1. Unblock drain hose. 2. Clean pump filter. 3. Make sure that drain hose is properly installed.

Problem	Cause	Solution
Strong vibration while spinning.	<ol style="list-style-type: none"> 1. Not all transportation bolts have been removed. 2. Appliance has no solid position. 3. Machine load is not correct. 	<ol style="list-style-type: none"> 1. Remove all transportation bolts. 2. Ensure solid ground and a levelled position. 3. Check load weight and balance.
Operation stops for a period of time.	<ol style="list-style-type: none"> 1. Appliance displays error code. 2. Problem due to load pattern. 3. Programme performs soaking cycle. 	<ol style="list-style-type: none"> 1. Consider display codes. 2. Reduce or adjust load. 3. Cancel programme and restart.
Operation stops before completing wash cycle.	Water or electric failure.	Check power and water supply.
Excessive foam floats drum and/or detergent drawer.	<ol style="list-style-type: none"> 1. Detergent is not appropriate. 2. Excessive use of detergent in manually dosage. 	<ol style="list-style-type: none"> 1. Check detergent recommendations. 2. Reduce amount of detergent.
Automatic adjustment of washing time	Washing programme duration will be adjusted.	This is normal and doesn't affect functionality.
Spinning fails	Unbalance of laundry.	Check machine load.Run the Spin programme again.

General information and tips:



If too much foam is visible during spin cycle, the motor will stop and drain pump will activate for 90 seconds. If that elimination of foam fails up to 3 times, programme ends without spinning.

Basic technical information regarding the appliance

Power source	220-240V/50Hz
Max. working current (A)	10
Water pressure (MPa)	$0.03 \leq P \leq 1$
Nominal load (kg)	10
Max spinning speed (rpm)	1400
Washing programmes	16
Max. power (W)	2000
Dimensions (HxDxW mm)	850x600x595
Net. weight (kg)	74
Power consumption of the off-mode (W)	0.2
Power consumption of the left-on mode (W)	0.2